

RADIO'S LIVEST MAGAZINE



February
25 Cents

Radio-Craft

HUGO GERNSBACK Editor

THE NEW TUBES

VARIABLE-MU
R.F. PENTODE

THE
"TRIPLE-TWIN"
OUTPUT
TUBE



See Page 458



Grand Island Monitor Station — The Gooseneck Voltmeter — S-W Converters
Radio Service and the Electrical Code — Short-Checkers and Pre-Heaters

SPEED

RADIO TUBES FOR ALL NEW RECEIVERS

EVER ABREAST OF THE RADIO TIMES

SPEED has achieved tremendous success
with these NEW tubes. The reason
is obvious—QUALITY



247

New power amplifier Pentode, for
use in the output stage of AC
receivers.

Here They Are!

No. 235

New screen grid tube—designed to reduce
cross modulation and similar distortion.

No. 551

New screen grid tube—designed for same
purpose as type 235, although having
slightly different characteristics.

No. 230

New general purpose tube, operating eco-
nomically at 2 volts, giving unusual service
though using very little power.

No. 231

New amplifier using 2 volts and extremely
low current consumption in same group as
types 230 and 232.

No. 232

New screen grid tube—for use as radio
frequency amplifier, operating at 2 volts.

No. 233

New power amplifier in the Pentode group,
operating on 2 volts with low current con-
sumption.

No. 236

New screen grid tube used mainly as R.F.
amplifier or detector in automobile sets.
In same group as type 237 and 238. Also
for use in D.C. sets.

No. 237

New general purpose tube—especially
adapted to automobile use. Can be used
either as a detector or amplifier. Also for
use in D.C. sets.

No. 238

New power amplifier Pentode for use in
automobile receivers designed for it. Gives
unusual volume for small input signal
strength.

No. S 84

Developed expressly for replacement of
type C 484 in Sparton sets. Somewhat
similar in characteristics to the type 227.

No. S 82 B

Developed expressly for replacement of the
the C 183 in Sparton sets, possessing all
peculiar characteristics necessary for this
purpose.

No. S 83

Developed expressly for replacement of
the C 183 in Sparton sets, possession all
the peculiar characteristics necessary for
this purpose.

SPEED Quality is Making History Today. Write for Complete Details.

Still another addition to a big family. **SPEED** FOTO-LECTRIC TUBES.
Standard gas-filled type, red sensitive, caesium on caesium-oxide silver-oxide.
Six months guarantee against defects. Write for FOTO-LECTRIC folder.

SPEED
CABLE RADIO TUBE CORPORATION



230-240 NORTH 9th STREET, BROOKLYN, NEW YORK

RCA
LICENSED

Train *with* R.T.A. *for* Radio Service Work

Important and far-reaching developments in Radio create sudden demand for specially equipped and specially trained Radio Service Men.



This excellent set analyzer and trouble shooter included with our course of training

MANY skilled Radio Service Men are needed now to service all-electric sets. By becoming a certified R. T. A. Service Man, you can make big money, full time or spare time, and fit yourself for the big-pay opportunities that Radio offers.

We will quickly give you the training you need to qualify as a Radio Service Man . . . certify you . . . furnish you with a marvelous Radio Set Analyzer. This wonder instrument, together with our training, will enable you to compete successfully with experts who have been in the radio business for years. With its help you can quickly diagnose any ailing Radio set. The training we give you will enable you to make necessary analysis and repairs.

Serving as a "radio doctor" with this Radio Set Analyzer is but one of the many easy ways by which we help you make money out of Radio. Wiring rooms for Radio, installing and servicing sets for dealers, building and installing automobile Radio sets, constructing and installing short wave receivers . . . those are a few of the other ways in which our members are cashing in on Radio.

As a member of the Radio Training Association, you receive personal instruction from skilled Radio Engineers. Upon completion of the training, they will advise you personally on any problems which arise in your work. The Association will help you make money in your spare time, increase your pay, or start you in business. The easiest, quickest, best-paying way for you to get into Radio is by joining the Radio Training Association.

This amazing Radio Set Analyzer plus the instructions given you by the Association will transform you into an expert quickly. With it, you can locate troubles in all types of sets, test circuits, measure resistance and condenser capacities, detect defective tubes. Knowing how to make repairs is easy; knowing what the trouble is requires expert knowledge and a Radio Set Analyzer. With this Radio Set Analyzer, you will be able to give expert service and make big money. Possessing this set analyzer and knowing how to use it will be but one of the benefits that will be yours as a member of the R. T. A.

Write for No-Cost Membership Plan

We have worked out a plan whereby a membership enrollment need not cost you a cent. Our thorough training and the valuable Radio set analyzer can be yours. Write at once and find out how easily both of these can be earned.

Now is the time to prepare to be a Radio Service Man. Greater opportunities are opening up right along. For the sake of extra money in your spare time, bigger pay, a business of your own, a position with a future, get in touch with the Radio Training Association of America now.

Send for this No-Cost Membership plan and Free Radio Handbook that will open your eyes as to what Radio has in store for the ambitious man. Don't wait. Do it now.

RADIO TRAINING ASSOCIATION OF AMERICA
Dept. RCA-2 4513 Ravenswood Ave. Chicago, Ill.

Fill Out and Mail Today!

RADIO TRAINING ASSOCIATION OF AMERICA
Dept. RCA-2, 4513 Ravenswood Ave., Chicago, Ill.

Gentlemen: Send me details of your No-Cost Membership Enrollment Plan and information on how to learn to make real money in radio quick.

Name
Address
City State

TRADE E MARKET ST
MAGAZINE & BOOKS

H. GERNSBACK, President
 S. GERNSBACK, Treasurer
 J. M. HERZBERG, Vice-President
 I. S. MANHEIMER, Secretary



HUGO GERNSBACK, Editor-in-Chief

R. D. WASHBURN
 Technical Editor

LOUIS MARTIN
 Associate Editor

VOLUME III
 NUMBER 8

Contents of This Issue

FEBRUARY
 1932

	PAGE		PAGE
EDITORIAL:			
The New Tubes.....By Hugo Gernsback	457	RADIO SERVICE DATA SHEETS:	
		No. 59—Majestic Model 25 9-Tube Twin-Detector Chassis, Superheterodyne Receiver Models Brentwood, Cheltenham, and Brucewood.....	478
NEW DEVELOPMENTS IN RADIO:			
New Tubes for Old.....By Louis Martin		No. 60—Howard Model 45 Automatic Volume Control Superheterodyne with Model AVH Chassis.....	479
The Variable-Mu R.F. Pentode.....	458	SOUND RECORDING DEPARTMENT:	
The Triple-Twin Power Tube (Part I).....	459	How to "Sync" Disc and Film (Part I) By Herbert C. McKay	468
Grand Island Monitor Station (Part I).....	460	TECHNICAL RADIO TOPICS:	
New Radio Equipment.....	462	A Gooseneck-Type Vacuum Tube Voltmeter By Beryl B. Bryant	466
SERVICE MEN'S DEPARTMENT:			
Dissecting A Modern Set Analyzer (Part I) By Floyd Fausett	465	Sound Equipment in the Hotel New Yorker (Part VI); How to Make A Microphone Mixer By Eli M. Lurie	467
Radio Service and the Electric Code (Part I) By Gus Jacobson and David Cohen	472	The Radio Craftsman's Page.....	469
Short-Checkers and Preheaters (Part I) By Jesse Tillet	474	Push-Push Receivers.....By C. H. W. Nason	470
The Service Man's Forum.....	476	Automatic A.C.-D.C. Operation.....By Alexis Ponce	471
Improving Operation.....By B. T. Stubbs	476	A Self-Powered S-W Converter.....By M. H. Gernsback	480
Operating Notes.....By Bertram M. Freed	477	Radio Kinks	482
		RADIO-CRAFT'S Information Bureau.....	484
		Book Review	495

In Forthcoming Issues

PERMEABILITY RECORDING. A new method of recording sound on a moving iron wire. External magnetic variations, and the element of time, do not enter into the permanence of the recording.

ELECTROLYTIC VARIABLE CONDENSERS. Complete details for making capacity variable up to about 4 microfarads. Useful for determining by substitution the capacity requirements of circuits.

SUBAQUEOUS SOUND. A description of recently completed development work on dynamic speaker-mikes especially designed for under-water operation between submarines in distress and rescue ships above.

RADIO FREQUENCY COIL DESIGN. The second portion of a discussion on R.F. inductances. This article on R.F. coil primary design is a companion to the previous one on secondary coil considerations.

RADIO-CRAFT is published monthly, on the fifth of the month preceding that of date; its subscription price is \$2.50 per year. (In Canada and foreign countries, \$3.00 a year to cover additional postage.) Entered at the postoffice at Mt. Morris, Ill., as second-class matter under the act of March 3, 1879. Trademarks and copyrights by permission of Gernsback Publications, Inc., 98 Park Place, N. Y. C.

Text and illustrations of this magazine are copyright and must not be reproduced without permission of the copyright owners. We are also agents for WONDER STORIES and WONDER STORIES QUARTERLY. Subscriptions to these magazines may be taken in combination with RADIO-CRAFT at reduced Club rates. Write for information.

Copyright 1932, GERNSBACK PUBLICATIONS, INC.

Published by
TECHNI-CRAFT PUBLISHING CORPORATION

Publication Office: 404 No. Wesley Ave., Mount Morris, Illinois

Editorial and Advertising Offices
 96-98 Park Place, New York City

Chicago Advertising Office
 737 North Michigan Avenue, Chicago, Ill.

Western Advertising Office
 220 No. Catalina St., Los Angeles, Calif.

L. F. McClure, Chicago Advertising Representative

LOYD B. CHAPPELL, Western Advertising Representative

London Agent: Hachette & Co.,
 3 La Belle Sauvage, Ludgate Hill, E.C. 4

Paris Agent: Hachette & Co.,
 111 Rue Reaumur

Australian Agent: McGill's Agency,
 179 Elizabeth St., Melbourne

SAY FELLOWS
 GET INTO
RADIO-TELEVISION
 AND
TALKING PICTURES



Let me tell you how I can quickly train you, NOT by book study, but by actual shop training on real Radio, Television and Talking Picture equipment in 10 WEEKS in the great shops of COYNE in Chicago. Here at Coyne you don't need advanced education or experience and many of my students earn while learn- ing. After graduation I give them lifetime employment service. Here at Coyne too you get individual instruction and you can start anytime.

Radio offers jobs as Designer, inspector and Tester, Salesman, and in installation work, operator of a broad-casting station, wireless operator on a ship, with Talking Pictures theatres - with Television Laboratories and studios. Television alone will soon be calling for thousands of trained men.

Come to Coyne here in Chicago and prepare for one of

these jobs the quick and practical way - BY ACTUAL SHOP WORK.

It's a shame for any fellow to go thru life as an untrained man working at small pay, and never even sure of a steady job, and when he does work working at any old price they want to pay him.

You can avoid this. You can be a trained man and have a real future. Mail the coupon today and I'll send you my big Free book and tell you how you can be a success just as hundreds of my graduates or Achieve

H. C. LEWIS, PRESIDENT
 Radio Division, COYNE ELECTRICAL SCHOOL
 500 S. Paulina St., Dept. 22-8H Chicago, Ill.

Send me your Big Free Radio and Television Book, and tell me how I too can make a success in Radio.

Name

Address

City State

**Your
Copy
IS Ready!**

\$5.00

The Copy

HUGO GERNSBACK,
Editor

C. E. Denton
Managing Editor

Clyde Fitch,
Managing Editor

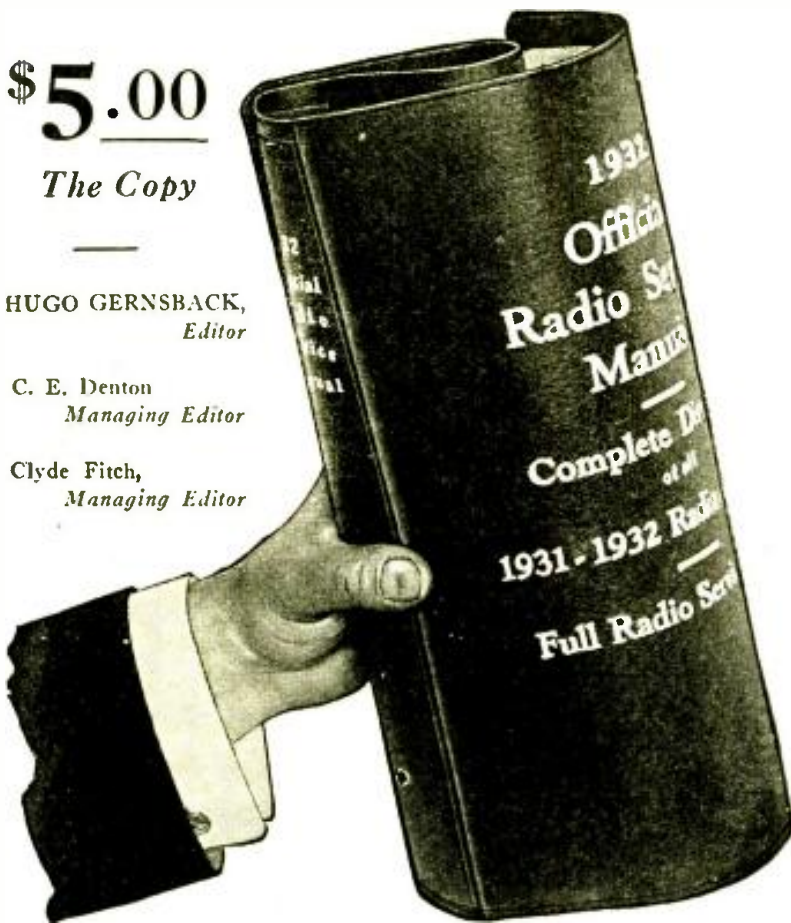

Partial Contents of Manual Volume No. 2

A step-by-step analysis in servicing a receiver which embodies in its design every possible combination of modern radio practice; it is fully illustrated and thoroughly explained. It is the greatest contribution to the radio service field.

Chart showing the operation of all types of vacuum tubes, whether new, old or obsolete. An exclusive resume of the uses of the Pentode and Variable Mu Tubes and their characteristics.

Complete discussion of the superheterodyne and its inherent peculiarities. Also a special chapter on tools used on superheterodyne circuits.

Schematic diagrams and circuits complete with color codings.

Important chapters on commercial aircraft radio equipment; new data on commercial short wave receivers and converters.

Servicing and installation of public address systems and talking machine equipment.

Standardized color codings for resistors.

Operation of old and new testing equipment; tube voltmeters, output meters, oscillators and aligning tools.

A full section on Midget radios—their design, circuits and types. How to service them most economically.

Hundreds of schematic diagrams of older radio receivers which have never been published.

Blank pages for recording notes, diagrams and sketches; these pages are transferable to any part of the book.

Coupon page for free questions and answers.

Get Supplements

FREE

with the

NEW MANUAL

Vol. No. 2

After many months of extremely careful preparation by a large staff of editors and draftsmen, the New 1932 OFFICIAL RADIO SERVICE MANUAL, Volume No. 2, has been completed, and copies are ready for distribution.

There is so much new material in this Manual that a Service Man or dealer would be lost without it when called to service a set. Information about new models which are on the market only a few weeks are contained in this book. The 1932 Manual makes the service kit complete. Every radio man should be equipped with this volume. Send for yours today!

The 1932 Manual contains a Full Radio Service Guide and a Most Complete Directory of all 1931-1932 Radio Receivers as well as models of older design.

THERE IS NOT A SINGLE DIAGRAM IN THE NEW MANUAL, VOLUME 2, WHICH HAS APPEARED IN THE FIRST VOLUME.

**Complete Directory of All 1931-1932 Receivers,
Full Radio Service Guide.**

For Radio Service Men, Jobbers, Dealers, Manufacturers and Set Builders.

Over 1,000 Pages (Including Supplements)

Over 2,000 Diagrams, Charts and Illustrations

Flexible, Looseleaf Binder, 9 x 12 inches

Mail Coupon Today!

GERNSBACK PUBLICATIONS, Inc.,		RC-2
96-98 Park Place, New York, N. Y.		
I enclose herewith remittance of \$5.00, (check or money order preferred) for which you are to send me the NEW 1932 OFFICIAL RADIO SERVICE MANUAL. I understand that only New material will be included in the Manual and Supplements will be mailed FREE every 60 days.		
Name		
Address		
City	State	

63 FOREIGN COUNTRIES

get dependable 'round the world reception with

SCOTT ALL-WAVE RECEIVERS



Darkened areas show the foreign countries in which Scott All-Wave Receivers are depended on for radio contact with the rest of the world.

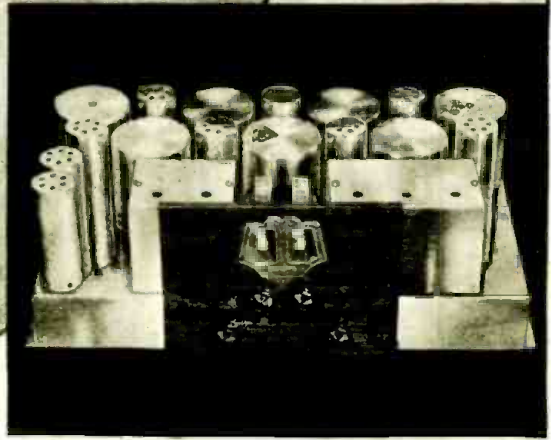

Sturdy Construction Protects Precision Adjustments

The precision work, which gives the Scott All-Wave its supremacy is assured constancy by the heavy steel chassis—rigid as a bridge, and chromium plated to protect it from deterioration. The All-Wave chassis is so sturdily built that it is unconditionally guaranteed for five full years. Any part proving defective within that time will be replaced free of charge.

Write for Full Details

Surely, a 15-550 meter receiver that will satisfy the exacting requirements of 63 different foreign countries, will suit your needs better than any other. Surely, a receiver that is tested on reception from London and Rome before shipping is the receiver you would rather own. Mail coupon today for full particulars of the Scott All-Wave Receiver. (Name and address of Scott owner in any foreign country, sent on request).

Not only in America, is the Scott All-Wave supplying an entirely new concept of radio performance. In other lands too—in difficult spots, this receiver is doing equally sensational work. For instance, atmospheric conditions are so bad in the Canary Islands that reception there has always been considered almost impossible. Scott All-Wave Receivers located in the Canary Islands, bring in stations 9,000 and 10,000 miles away with good clarity and volume. But it is the underlying reason for such amazing performance that interests you!

The Scott All-Wave Receiver is so powerful and so sensitive, that when operated with the volume turned way down below the noise level, there is still more than enough sensitivity to give ample loud speaker reproduction of signals originating 9,000 and 10,000 miles away. This is one of the main reasons why Scott All-Wave Receivers are being used with complete success in 63 foreign countries today—why Scott owners in this country can tune 'round the world with their receivers whenever they choose—and why YOU will want a Scott!

What is the Difference that makes the Scott All-Wave so much Better?

The Scott All-Wave is not a factory product. It is built in the laboratory by experts and to laboratory exactness. Physical measurements are by the micrometer—electrical measurements are computed to the smallest fractions—each nut and bolt, each wire, and each operation, no matter how small, is performed by a man with a thorough technical understanding of radio.

The result is a precision-built receiver capable of doing things that factory-built receivers can never hope to do. The result is sensitivity so great that Chicago owners can listen to G6SW, Chelmsford, England; 12R0, Rome; VK3ME, Sydney; HRB, Honduras; and many others any day they choose. The result is also perfect 10 Kilocycle selectivity. No "cross talk." And the resulting tone is nothing short of downright realism—full, round and natural.

These Foreign Countries Now Served by SCOTT ALL-WAVE RECEIVERS

1. ALASKA
2. ARGENTINE
3. BARBADOS
4. BELGIUM
5. BERMUDA
6. BRAZIL
7. BRITISH GUIANA
8. BRITISH OCEANIA
9. CANADA
10. CANAL ZONE
11. CANARY ISLANDS
12. CHILE
13. CHINA
14. COLOMBIA
15. COSTA RICA
16. CUBA
17. CZECHOSLOVAKIA
18. DOMINICAN REPUBLIC
19. ECUADOR
20. EGYPT
21. ENGLAND
22. FINLAND
23. FRANCE
24. FRENCH WEST AFRICA
25. FRENCH WEST INDIES
26. GERMANY
27. GREECE
28. GUATEMALA
29. HAWAII
30. HONDURAS
31. INDIA
32. ITALY
33. JAMAICA
34. JAPAN
35. MALTA
36. MEXICO
37. NETHERLANDS
38. NETHERLANDS EAST INDIES
39. NETHERLANDS WEST INDIES
40. NEW ZEALAND
41. NICARAGUA
42. NORTH AFRICA
43. NORWAY
44. PANAMA
45. PERU
46. PHILIPPINE ISLANDS
47. POLAND
48. PORTO RICO
49. PORTUGAL
50. SALVADOR
51. SAMOA ISLANDS
52. SCOTLAND
53. SIAM
54. SOUTHERN Rhodesia
55. SPAIN
56. SWITZERLAND
57. TRINIDAD
58. UNION SOUTH AFRICA
59. URUGUAY
60. VENEZUELA
61. WALES
62. YUGOSLAVIA

The E. H. SCOTT RADIO LABORATORIES, Inc.
 FORMERLY SCOTT TRANSFORMER CO.
 4450 Ravenswood Avenue Dept. C-2 Chicago, Illinois

CLIP

The E. H. Scott Radio Laboratories, Inc.
 4450 Ravenswood Ave., Dept. C-2
 Chicago, Illinois

Send me full details of the Scott All-Wave, 15-550 meter superheterodyne.

Check here if Set Builder Dealer Radio DXer

Name

Street

Town State

NOW A Powerful New 11-Tube Super Heterodyne at a Sensationally Low Price!

Save 50%
up to



Easy Terms

Pay as you Play Your Mid-west! Terms as low as \$5.00 Down

only \$37.50
COMPLETELY ASSEMBLED
With Specially Matched Large DYNAMIC SPEAKER

30 DAYS FREE TRIAL

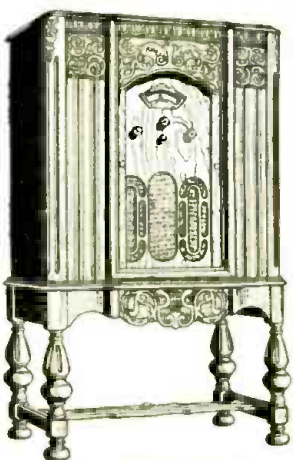

Complete Line of Consoles

Rush the coupon for big, beautiful catalog that illustrates the complete line of MID-WEST console cabinets. All new, all different, all priced to save you 30% to 50%. You'll reap with admiration when you see the vast selection of beauty, style and grace that is crafted into every MID-WEST Console. The catalog is FREE—it doesn't cost you a penny! Rush the coupon—NOW!

Deal Direct with Big Mid-West Factory
—Save Middlemen's Profits

Never before in the history of radio has such a powerful set been offered at Mid-West's amazing low price. Deal direct with the big MID-WEST factory. Save the jobber's profit. Your outfit will reach you splendidly packed, rigidly tested with everything in place ready to plug in. No assembling! Entertain yourself for 30 days absolutely FREE—then decide. Save up to 50 per cent in buying direct from factory—insure satisfaction—deal direct with the world's veteran radio builders—MID-WEST. And don't forget—every MID-WEST outfit is backed by an absolute guarantee of satisfaction. You take no risk.

Push-Pull Pentode Power Output Tubes—Multi-Mu Screen Grid Tubes—Real Automatic Volume Control—All the Latest Improvements That Give Amazing Clarity, Perfect Tone, Split-Hair Selectivity and Sensitivity Never Before Heard Of!

RADIO-FANS! Just what you've been looking for! A powerful, new 11-tube radio at an unbelievable low price. And what a radio! Two Push-pull pentode power output tubes with twice the power and four times the sensitivity of ordinary 45's—and three Multi-Mu tubes, together with a —24 first detector, gives you SIX SCREEN GRIDS. These six screen grids, together with the —27 oscillator, second detector first A.F., and automatic volume control—the —80 tubes—gives a total of ELEVEN TUBES, with reception equal to fifteen ordinary tubes—in a perfectly balanced, non-oscillating, non-radiating, super-heterodyne TEN-TUNED circuit with real Automatic Volume Control that holds those powerful locals down to the same volume as the distant stations and counteracts that annoying fading on weak stations.

The use of a band-pass or pre-selector stage, together with Multi-Mu tubes, makes this radio actually surpass 10 K.C. selectivity. Absolutely eliminates those noisy singing "birdies" and annoying cross talks. You'll be positively amazed and delighted when you see this sensational new set. hear the beautiful mellow, cathedral tone—know what it means to have that pin-dot selectivity and unequalled sensitivity.

Be convinced—TRY IT 30 DAYS FREE. Don't send a penny. Mail coupon right now for amazing FREE trial offer and complete details. You'll be surprised.

TERMS as low as \$5.00 DOWN

Big Pay for USER AGENTS

If you are interested in making BIG MONEY in spare time for just showing your MID-WEST Radio to friends and neighbors, then check the coupon and mail it immediately for complete details. Special guarantee and FREE trial offer eliminates all risk. Your big opportunity—Hurry!

RUSH THIS COUPON FOR AMAZING FREE TRIAL OFFER AND BIG BEAUTIFUL CATALOG

Enclose Special "User Agent" proposition.

Gentlemen: Please rush me copy of your big, beautiful new catalog and complete details about the powerful, new 11-tube super-heterodyne outfit. This is not an order, and I am not obligated.

Name _____ Address _____ Town _____ State _____

MID-WEST RADIO CORP.
DEPT. 35 CINCINNATI OHIO
EST. 1919

The PILOT Short Wave Converter Adds These 5 Interesting Wave Bands to Your Present Broadcast Receiver

**Band One:
10 to 19 Meters**

Alive during morning hours with American and foreign radio telephone and short wave relay broadcasting stations. It's great sport to hear London, Berlin and Buenos Aires talking to New York; or Eindhoven (Holland) conversing with Sourabaya (Dutch East Indies).

**Band Two:
19 to 35 Meters**

After lunch, skip up to band two and hear Chelmsford, England; Pointoise, France; or Königswusterhausen, Germany. Also ship-to-shore radio-telephones, and American and Canadian broadcasters. Rome may be on with an opera, or Mexico City with a news report.

**Band Three:
35 to 65 Meters**

Always a source of thrills. Dozens of North American, Central American and South American broadcasters, easily heard during the early evening. Entertain your guests with music from Costa Rica and Colombia. From California and Canada.

**Band Four:
65 to 110 Meters**

Actually hundreds of amateur phone stations, all over the country, operate in this band. You can listen to them for hours. Also airport and airplane stations, which are heard at all hours of the day and night.

**Band Five:
110-200 Meters**

Nothing is more thrilling than to hear the police radio stations directing "cruiser" cars to scenes of crimes or accidents. You live with the news while it is happening! Experimental television stations are also in this band.

Brings in Foreign Stations on the Loud Speaker

No Coils to Change

PILOT Short Wave Converter



Self-Contained Self-Energized

Price, complete with four tubes, ready to operate (no kits; in factory built form only)... **\$39.50**

Connects in 2 Minutes With 2 Simple Wires—Nothing to Disturb

Uses two 224A's, one 227, one 280. Operates as a superheterodyne frequency changer. Works with any TRF or super-het broadcast receiver; affords enormous amplification with knife edge selectivity. Five wave ranges covered by the twist of a knob. Single dial tuning with non-critical antenna trimmer. Opens the whole absorbing field of short wave radio to any member of the family old enough to turn a knob.

Also a Complete Combination Set— The New PILOT SUPER-WASP

Complete with 11 tubes, ready to operate (no kits; in factory built form only) **\$99.50**

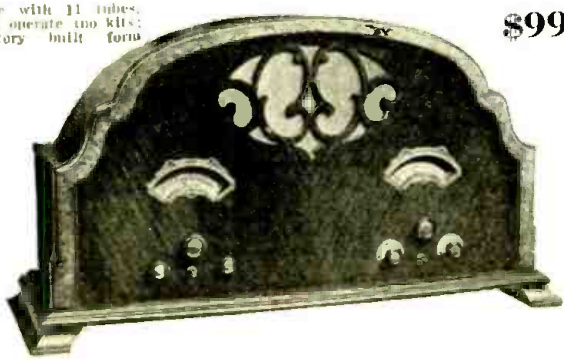

The 1932 SUPER-WASP—the latest model of the internationally famous receiver for short wave and broadcast reception. On the short waves it is a double superheterodyne of eleven tubes, working on two intermediate frequencies: 559 kc. and 175 kc. Has full throated dynamic speaker. Brings in the foreign stations with unbelievable volume.

YOUR DEALER
Can Supply
You With
PILOT
SHORT WAVE
and
BROADCAST
SETS

PILOT RADIO AND TUBE CORPORATION, LAWRENCE, MASS.

- Please send me full technical "dope" on the new Pilot Short Wave Converter and the new complete Super-Wasp. Free, no obligation on my part.
- Please send me a free sample copy of Radio Design.
- Enclosed is 50c. Enter my subscription to Radio Design for one year.

Name Street and Number.....
City State..... RC



Super Power

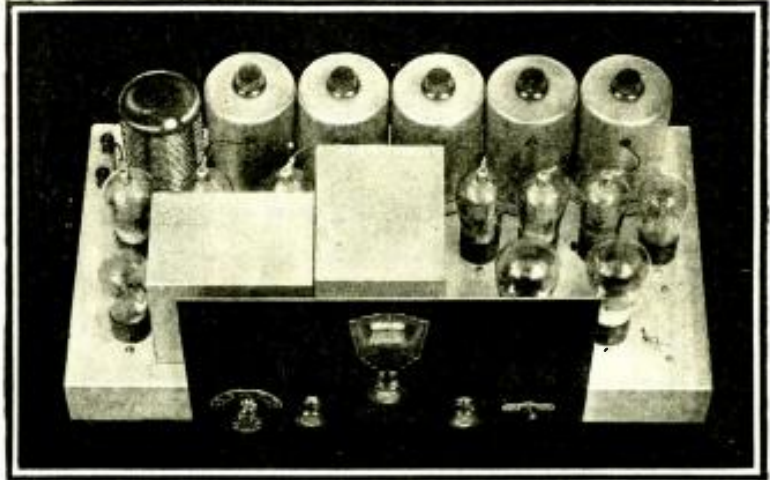

insures

World-Wide Performance- 15 TO 550 METERS-NO PLUG-IN COILS

THE phenomenal ability of Lincoln DeLuxe receivers to receive stations from every corner of the globe is largely due to Lincoln Super-Power. The tremendous gain of Lincoln's highly efficient circuit opens a new field for the radio listener. National and international programs, fascinating foreign broadcasts, short-waves, air-mail, trans-Atlantic phone,—these and many other features are available to the Lincoln owner.

From 15 to 550 Meters at the Touch of a Switch

One of the outstanding advances in radio design of recent years is the elimination of plug-in coils for short-wave reception. Having designed the DeLuxe to tune from 15 to 550 meters, Lincoln engineers perfected an extremely efficient and ingenious design whereby a small no-capacity selector switch makes the contacts formerly made by the coil prong and socket contact. A Lincoln owner may change from broadcast to any one of four short-wave bands by merely turning the selector switch.

A New Conception of Short-Wave Reception

The application of Lincoln's mighty power to the reception of short-waves produces truly amazing results. Stations half-way around the world come in with clock like regularity. Lincoln enthusiasts in the central states have

repeatedly reported *broadcast* reception of many trans-Pacific stations. The tremendous amplification of the highly engineered Lincoln circuit is always perfectly controlled in a channel less than 10 K.C. wide. A letter from Alaska reports reception of Mexico, Nebraska and Vancouver, B. C., all three stations 5 K.C. apart!

Full, Rich, Life-Like Lincoln Tone

Lincoln tone is a revelation of purity and fidelity. Lincoln experts have designed an audio system that, with either radio or phonograph pick-up input, delivers tone of astonishing richness and realism. Artificial tone compensators or control devices are not required to bring out the natural vivid tone of the living artist.

DeLuxe DC-SW-10, Battery Model, Is Extremely Efficient

The Lincoln DeLuxe DC-SW-10 is the battery model version of the famous DeLuxe SW-32 described above. Taking advantage of the new low drain 2 volt tubes, the DC-SW-10, when operated from an adequate battery source, provides exceptionally quiet, crystal clear reception of both broadcast and short-waves. This model, although intended for rural or un electrified areas, is finding increasing favor in congested city communities because of its absolute freedom from line noise and clear life-like tone quality.

Clip and Mail NOW!

**LINCOLN
DE LUXE-SW-32**

LINCOLN RADIO CORPORATION

Dept. RC-2, 329 S. Wood St., CHICAGO, ILL.

Please send descriptive literature to NAME.....

ADDRESS.....

CITY.....

STATE.....

FEBRUARY
1932
Vol. III—No. 8



HUGO GERNSBACK
Editor

"Takes the Resistance Out of Radio"

Editorial Offices, 96-98 Park Place, New York, N. Y.

THE NEW TUBES

By HUGO GERNSBACK

IN those experiments of the vintage of 1919 in advance of the broadcast era starting in 1921, the trials and tribulations that were had with the old tubes will be recalled. We started out originally with the De Forest "Audion" which, in some respects, was not much better than a crystal, and in others, somewhat worse. Then we graduated to the VT-2's, the War tubes, which were considerably better but still left much to be desired. For one thing, the current consumption of these tubes was really terrific—each consumed 2 amperes. Today, this power consumption causes us to shudder.

Later on, we graduated to low-current consumption tubes, such as the WD-12's and 199's, which represented a great step forward. They were very good tubes, all of them being used for many purposes such as detectors, R.F. and A.F. amplifiers, and oscillators.

The last decade has seen revolutionary changes in tube construction, and it is now literally true that tubes are made for practically every purpose that one can think of—and the end is by no means in sight. Refinements are being announced almost daily, and it seems certain that during the next ten years we will have at least ten times as many new tubes as we have had during the past ten years, with characteristics that we cannot even foresee today.

The sensitivity of new tubes seems to increase with every announcement, and at a rate undreamed of even five years ago. It is literally true that our four-tube sets of today are more sensitive than the ten-tube sets of five years ago. This, of course, is mainly due to the high sensitivity of present-day tubes and to the greater power of our broadcast stations.

Of the new tubes announced in this issue of RADIO-CRAFT, we have first, the R.F. Variable-Mu Pentode, type '39. While this tube is properly an automotive variable-mu pentode, it can be used for many other purposes besides automobile work.

This tube may replace the '36 type which, as is well known, is a screen-grid tube; the substitution can be made without altering the socket connections. The only changes necessary are the replacement of the volume control (the size depending upon the type used) and the increasing of the screen-grid potential to about 100 volts. In addition, the new tube will also increase the sensitivity of the receiver without changing the number of tubes, which, of course, is a valuable feature in automobile radios. It will also reduce interference from nearby stations, as well as from the ignition system of the car. Furthermore, it will allow better control of volume than the '36.

For the experimenter, this tube should be especially valuable, as there are many receivers at the present time, particularly those of an experimental nature, that may be changed to use this tube.

Service Men may increase their incomes by displaying these new tubes to prospective customers, and showing them how their sets can be made vastly better by the addition of these tubes; the installation of the new volume control which this

tube necessitates will also mean some extra money.

The "triple-twin" type 295 is one of the tubes which I have foreshadowed in several of my editorials, the idea being to have several tubes combined into one; this is exactly what the 295 type does, since it combines, essentially, a type '27 and a type '45 in a single bulb. The internal connections are such that it can only be used as a direct-coupled stage. The socket connections are described in this issue of RADIO-CRAFT, and are interesting from a number of viewpoints.

The tube is chiefly important because the amount of amplification that can be secured from it is greater than if a single '27 and a '45 are used separately. This immediately suggests a tremendous new use in midget and semi-portable receivers; in fact, in any set where space is at a premium. The idea of using two tubes with a single base which results in a saving of space, is a highly attractive one to set manufacturers and experimenters, and it is certain that the new 295 tube will become very popular in view of these advantages.

Then also, in changing the wiring of present-day receivers to incorporate this new tube, the operating costs are reduced at once; we have, on the other hand, increased fidelity and volume, as well as increased over-all simplicity.

While it is true that it is necessary to make some changes in present-day receivers to incorporate the 295 tube, the changes are not difficult. The entire audio-frequency end of the receiver is to be removed, and the new tube can then be installed without undue trouble. RADIO-CRAFT, in forthcoming issues, will particularly dwell on these points; and, of course, this tube will be especially attractive to experimenters who wish to build single-tube sets that operate loud-speakers—a thing that was possible only theoretically heretofore, but should now become a reality. In the next issue of RADIO-CRAFT, such a receiver will be presented to our readers.

Of course, this tube is only the forerunner of others. It is only one of the many new twin tubes of this kind that will make their appearance.

Then, it should always be remembered that whenever a new tube is announced, it takes time before engineers work out the best characteristics and operating points; also, as a rule, new equipment and other refinements are required in order to obtain the highest efficiency from it.

An example of what I have in mind might better be cited: when the screen-grid tube made its first appearance, no one knew exactly what to do with it. It took almost a year before the introduction of new circuits that proved the tremendous superiority of this tube over the three-element tube, and not until then was it universally adopted. This is true of all tubes. It takes time to digest their characteristics and translate them into practice.

In the meanwhile, a new haven has been opened to tube enthusiasts, and we shall be glad to hear from those who try, and discover, new uses for the new tubes.

NEW TUBES

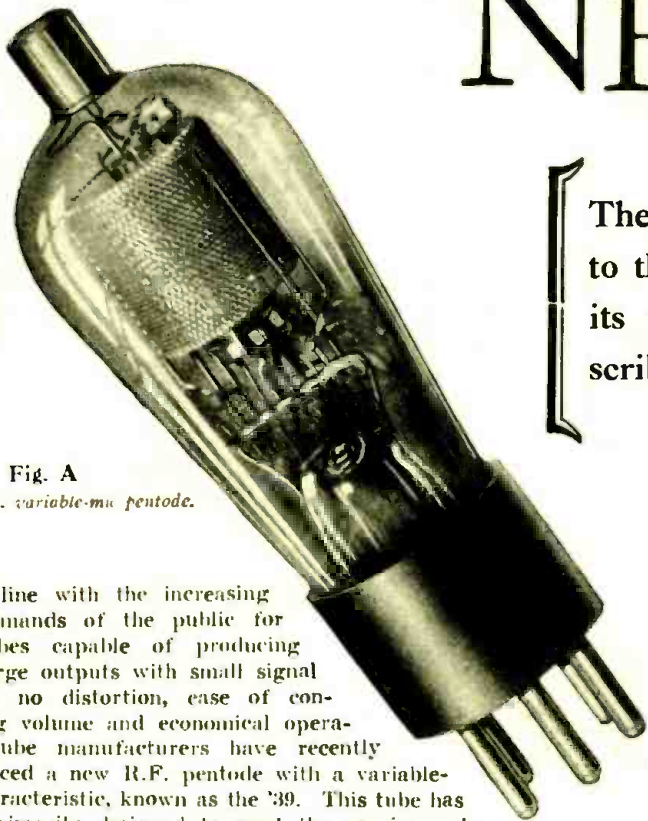

Fig. A
The R.F. variable-mu pentode.

The "39," a variable-mu R.F. pentode addition to the tube line. Every radio man should learn its characteristics. The author completely describes this newest vacuum-tube advancement.

By LOUIS

IN line with the increasing demands of the public for tubes capable of producing large outputs with small signal inputs, no distortion, ease of controlling volume and economical operation, tube manufacturers have recently announced a new R.F. pentode with a variable-mu characteristic, known as the '39. This tube has been primarily designed to meet the requirements of automobile and D.C. line-operated receivers where power supply is limited to 90 or 135 volts. It may be used in conjunction with its older brothers the '36, '37, and '38 without any change in circuit constants.

Operation of four-element tubes is somewhat critical in view of the erratic shape of the plate voltage—plate current characteristic at the low values of plate voltage. For comparison, the plate voltage—plate current curve of a '36 is shown in Fig. 1, and above it, the curve of the new '39. The '36 curve has a large dip with about 50 volts on the plate due to the effects of secondary emission, which is obviated in the '39 by the insertion of the fifth element—the suppressor grid. This grid, as in other pentodes, is interposed between the plate and the screen-grid in order to straighten out the "bump" in the curve. Let us see how this is accomplished.

An electron, upon leaving the filament, is attracted to the positively charged plate. Upon reaching it, its velocity is so great that it dislodges electrons from the plate. These electrons are known as secondary electrons, which find themselves between two attractive forces, one due to the positive plate potential, and the other due to the positive screen-grid potential. If the plate potential is low, the secondary electrons will be attracted to the screen-grid, which means that the net flow of electrons to the plate is diminished, lowering the plate current. This is the reason for the dip in the curve of the screen-grid tube.

The Pentode Element

Now if another grid be interposed between the plate and the screen-grid, and connected to the filament, the plate is offering the greatest attractive force, resulting in the secondary electrons being attracted to the plate, eliminating the undesirable dip in the curve. Thus the resulting tube, a pentode, has the

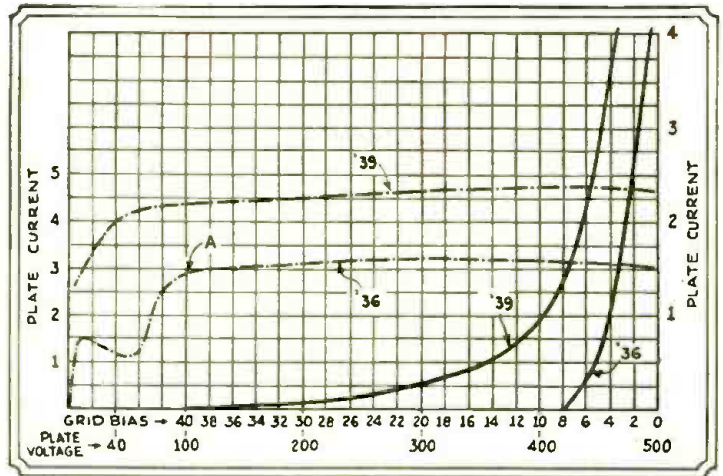

Fig. 1

The full-line curves correspond to the ordinates on the right, while the dot-dash curves correspond to the ordinates on the left.

smooth curve shown in the figure. During the time that a signal is impressed on the grid, the plate voltage fluctuates between wide limits, and if the curve has a dip, distortion is bound to result. The addition of the fifth element in a tube used for R.F. amplification results in a greater voltage output than could be secured without the use of this element.

Variable-mu tubes have been in use for quite some time and their features are well understood by the Service Man. To appreciate the characteristics of the '39, let us first examine the grid voltage—plate current curve illustrated in Fig. 1, which is accompanied by the curve of the '36 for comparison.

Note first, that for small grid biases the plate current is greater in the '39 than in the '36, and furthermore the plate-current variation, for a given grid-voltage swing is also greater in the '39 than in the '36. This means that the mutual conductance of the new tube is greater than that of the '36. For large biases, the '36 blocks

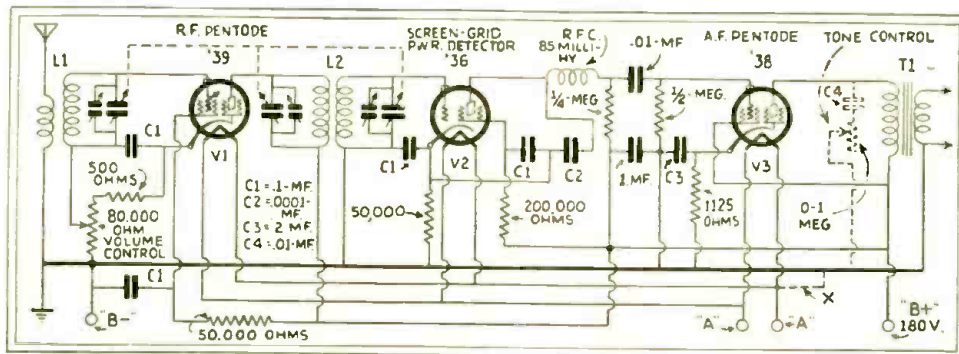

Fig. 4

Schematic diagram of a three-tube receiver using the new '39, a '36 and a '38, which is suitable for automotive work. Observe the position of the volume control.

(Continued on page 486)

FOR OLD

Announcing the new triple-twin "two-in-one" power tube—constituting a two stage direct-coupled A.F. amplifier. Data in this and subsequent issues reveal its characteristics and uses.

MARTIN

It is customary practice to consider the efficiency of an output tube as the ratio of A.C. power to D.C. plate dissipation. For a given power output, when the input signal is confined to the negative portion of the grid voltage—plate current characteristic due to grid-current limitation, the anode voltage to produce this output must be high to draw the electrons through the negative field produced by the heavily-biased grid. When using a zero grid-bias and allowing the signal to swing equally into the positive and negative regions, the same power output is obtained at greatly reduced plate voltage.

In actual triode operation, the efficiency is lowered by the necessity of operating into a load about twice the tube's internal impedance. The "triple-twin" illustrated in Fig. A, however, oper-



Fig. A
The new triple-twin.

itself from its heater and the output filament. This cathode is internally connected to the output grid.

Referring to Fig. 1, the fundamentals of the circuit will be discussed. The input of the first section is similar to usual operation, as this grid does not take current, but it differs in that the cathode is above ground potential. The signal reaches the cathode through a small condenser C1, offering a low impedance to the incoming signal. The grid receives its bias by the D.C. drop in the load impedance of the first section and the IR drop in resistance R2. The D.C. return path to this grid is through resistance Rg. It is significant that the load impedance of the first section exists between cathode and ground and is substantially the combined parallel value of resistance Rc and the input grid impedance of the second section. The inductance L1 is shunted across this combination but its impedance is high, except at low frequencies, compared to the other values, and its function is to allow a low D.C. resistance path for grid and plate returns. Its D.C. component also augments the voltage drop in R2 but the effect is negligible as the resistance of its winding is small. Resistance R1 establishes the grid of the output section several volts negative and is only necessary in A.C. operation to suppress hum. Condenser C2 bypasses the audio frequency. The plate circuit of the second section is identical to triode operation.

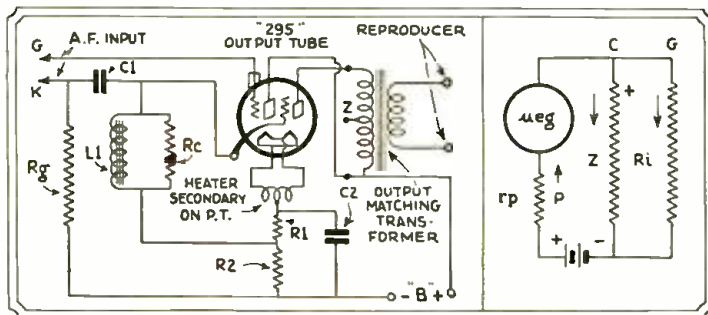

Fig. 1, left. Diagram of a direct-coupled amplifier using the triple-twin.
Fig. 2, right. The equivalent of the diagram in Fig. 1.

ates into an output load nearly equal to its own impedance (which represents an ideally loaded generator).

In pentode operation, a positive auxiliary (suppressor) grid reduces the space-charge effect, thus improving the efficiency, as compared to a triode. However, the auxiliary grid consumes energy, and a "cathode grid" is necessary to reduce eccentric characteristic curvature caused by primary and secondary plate electrons. To overcome the shielding effect of this latter grid, a higher plate potential is necessary. Further reduction of efficiency is caused by the necessity of operating into a load approximately one-fifth of the tube's internal impedance.

In analyzing the efficiency of an amplifier, the ratio of power output to the combined D.C. plate-dissipation of the component tubes must be considered. Therefore, if the sensitivity of one tube is high enough to eliminate a stage or stages, the effective efficiency becomes greater.

Fundamental Circuit

The triple-twin, "295," and its associated circuit permits positive grid swings and utilizes self-compensation for the flow of grid current. This tube contains two sets of three elements; the first set handles the input, and the second, the output. The input section employs an indirectly-heated cathode in order to electrically isolate

Theory

It is apparent that when the grid of the second section swings positive, and therefore draws current, its impedance cannot be considered constant, but some function of the positive cycle of the voltage developed across cathode and ground.

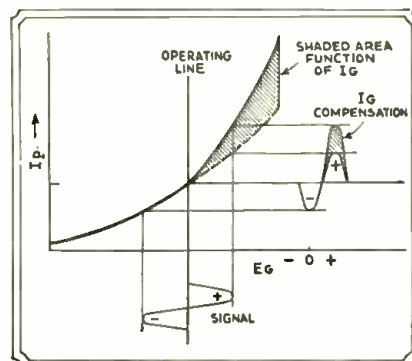

Fig. 3

The difference between the solid and dotted portions represents the additional plate current supplied by the first tube.

This simply represents a changing load to the first tube. It is significant that this voltage exists between cathode and ground because it is then in phase with the pulsating plate-current. This means that during the time the second grid is positive, the applied signal is likewise positive. There exists a slight phase difference between these two voltages depending upon the reactance of the circuit. This is, of course, opposite (Continued on page 487)

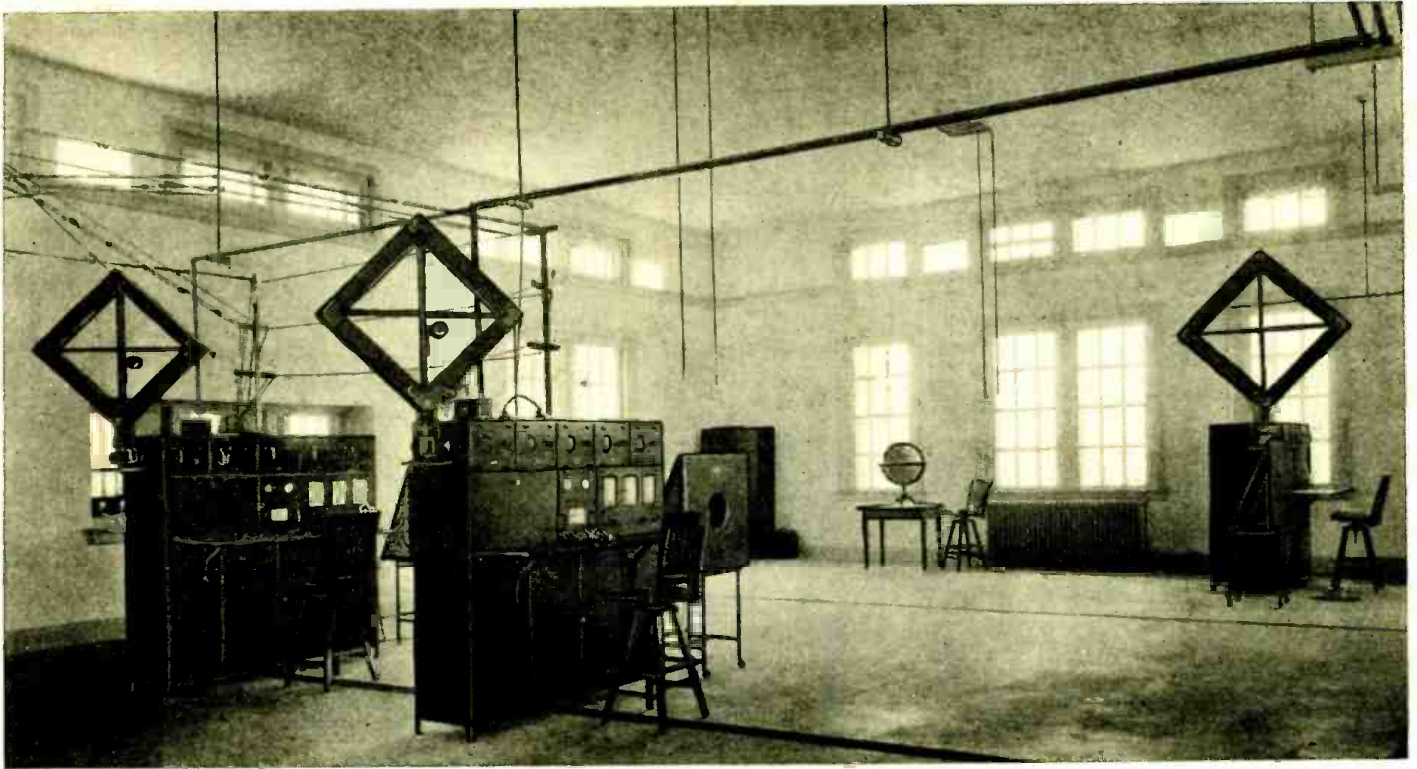

Fig. B. One-half of the main instrument room of Uncle Sam's "air police." Every point of the compass is under inspection, at will.

GRAND ISLAND

(PART

SINCE the advent of Radio, there has been an increasing need for some system of accurately checking the frequency of transmitted radio waves. Before the general use of crystal-controlled transmitters, calibrated wave-meters served their purpose very well. However, in order to have any regulation of radio transmitters it is absolutely essential that the methods of measuring used by the regulating agency be far more accurate than any method used by the stations involved.

THE discovery of the great value of high frequencies in radio made the problem of frequency measuring an international, as well as a national one.

Several years ago, Mr. S. W. Edwards, then Supervisor of Radio at Detroit, Michigan, foresaw the value of a centrally located monitoring station, supplemented by several strategically located secondary standards, and bent his efforts toward securing such a system for the Radio Division of the Department of Commerce.

The appropriation of approximately \$400,000 for land and buildings having been secured, the next problem was to draw up a primary standard and associated equipment, and eight secondary standards and their associated units.

It was then found that few companies were able to build measuring equipment of the required accuracy and receivers of the necessary sensitivity and selectivity. The award was finally made to the Westinghouse Electric & Manufacturing Company, and a great deal of the equipment now used has been manufactured by them.

Location of Station

With the manufacture of equipment well under way, the next move was to secure a location for the central frequency monitoring

station. An extensive field strength survey was made of the middle-west, and finally Nebraska was chosen as the most likely state in which to locate the station. Several factors prompted the choosing of Grand Island as a location. Chief among these was, first, it is centrally located in the United States; second, the level nature of the terrain makes for receiving conditions approaching the ideal; and third, the action of the Grand Island Chamber of Commerce in selling the government fifty acres of land for one dollar.

The exact location of the station is six miles west of Grand Island. It was deemed necessary that the station should be several miles from any center of population, in order to get away from "man-made static." Considerable care was necessary in planning the station itself. As it is an isolated plant, it must be equipped with a good water supply, power supply, and heating and sewage-disposal systems. In order to satisfactorily accomplish the work required of the station, it was also necessary to build an extensive

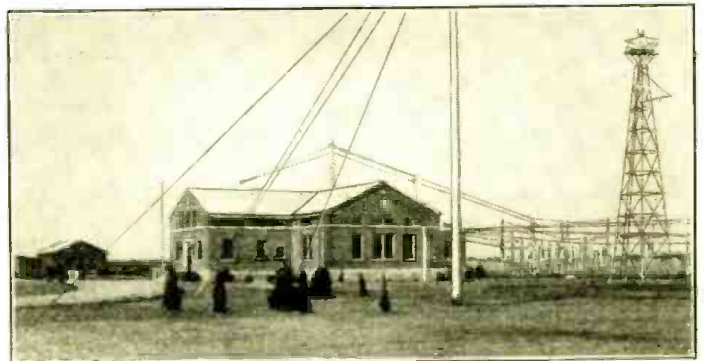

Fig. A

The main building, garage and engine room, plane beacon, and antenna system at the U. S. Monitor Station, Grand Island, Nebr.

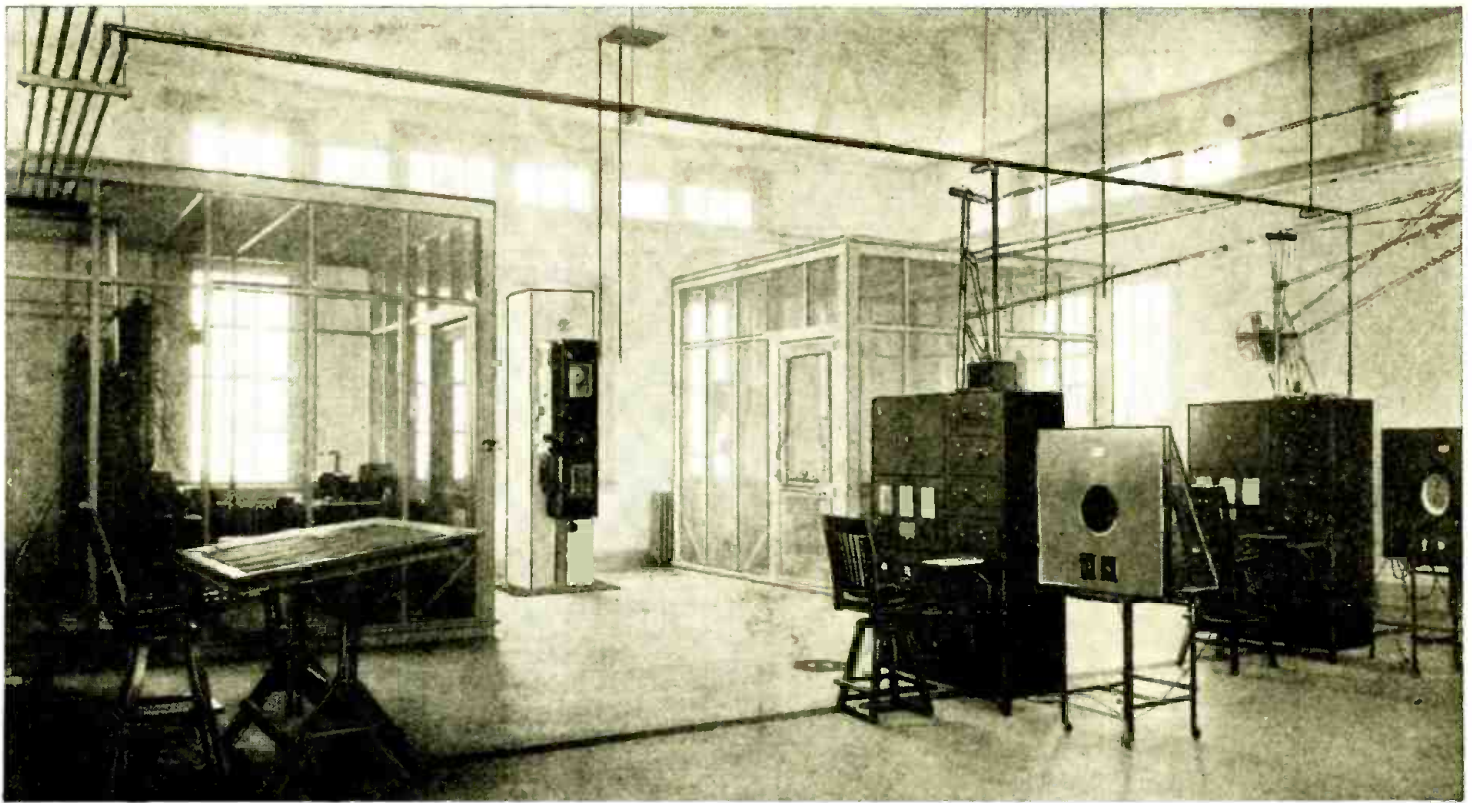

Fig. C. One-half of the main instrument room of the U. S. Government's broadcast station frequency monitor system at Grand Island.

MONITOR STATION

I)
antenna system.

A visitor cannot help but be somewhat impressed by the amount of detail that has gone into the construction of this Frequency Monitoring Station, and can readily see that to properly man all of this highly scientific equipment calls for a personnel of great ability who are well trained in their particular phase of the work. At present, there are 27 people employed at the station. In addition to the Manager (Mr. Benjamin Wolf) and Assistant Manager there are eight engineers, all of whom hold B.S. degrees in electrical engineering or have had wide radio experience, eight radio operators loaned the Radio Division by the Airways Division of the Department of Commerce, four Diesel engineers, one chief clerk, two stenographers and two janitors. This is enough to operate the station 16 hours a day. It is hoped that funds will be available later to add enough personnel to operate 24 hours a day.

It was mentioned in the first part of this article that in planning the station, the design engineer was confronted with the usual problems of an isolated plant, many of which were outside the radio field. Among these were the buildings, heating and sewage-disposal systems, and primary power supply. In this work, the help of the Bureau of Yards and Docks of the Navy Department was sought and obtained. The architect was F. W. Southworth of the Navy Department.

Buildings and Power Supply

There are two buildings, a main building shown in Fig. A, and a combination engine room and garage. The main building houses the radio equipment and heating plant. It is built of red brick and in the shape of a cross. The main floor has a motor-generator room, a battery room, work shop, main instrument room which is 72 x 85 feet, an office and a kitchen. The second floor has a dormitory and small office and the basement has a storeroom and boiler room. The kitchen and dormitory are for emergency purposes in case the personnel are storm bound.

The other building is built also of red brick and is divided into a four-car garage, a work shop, and engine room.

The primary power supply is two 40-H.P. Diesel engines driving 240-volt, 60-cycle, 3-phase alternators. Diesel engines were used in order to eliminate ignition interference. The engines are Fairbanks-Morse 3-cylinder, 2-cycle Marine type. Two 2000-gallon fuel oil tanks, buried outside the engine room, furnish fuel oil for both the Diesel engines and the oil burning furnace in the main building. The power from the alternators is made available in the main building through underground lines to a distributing panel in the motor-generator room. Motor-generator sets and rectifier units provide the necessary D.C. for battery charging. The standards and receivers, shown in Figs. B and C, are all operated from battery supply.

In the engine room beside the engines and their associated equipment, is a motor-driven pump which is capable of delivering 125 gallons of water per minute. The capacity of the well itself is in excess of 500 gallons a minute. This well is used to furnish the general water supply as well as an irrigation supply for seven

(Continued on page 489)

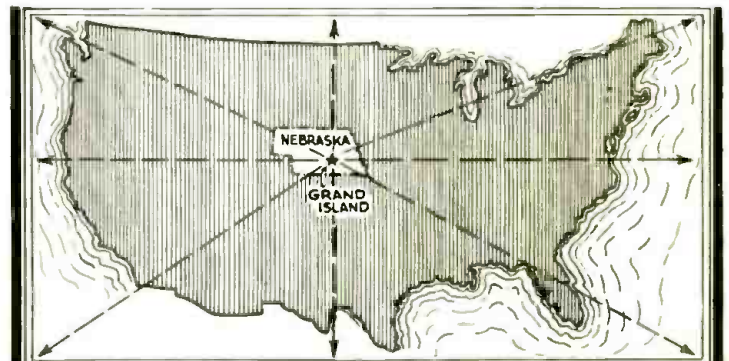
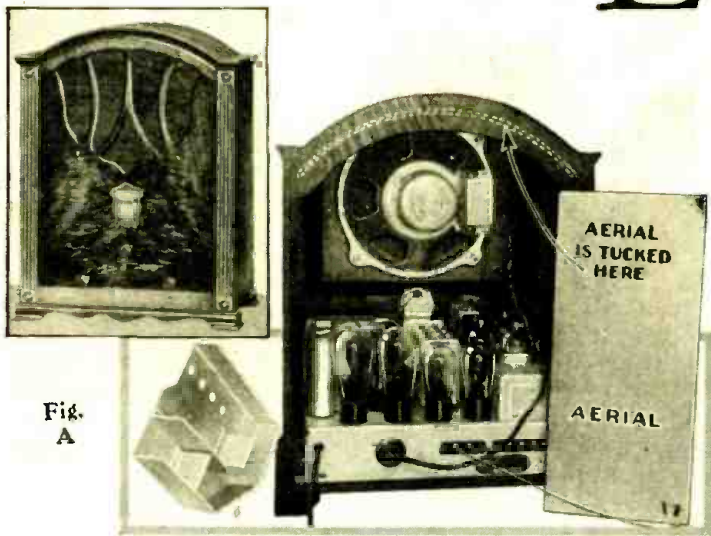

Fig. 1

Grand Island, Nebraska.—the most desirable spot in the United States for the reception of all our broadcast station programs.

NEW RADIO EQUIPMENT



Left, front view, and; right, rear view of the Crosley "Tenstrike" ten-tube automatic volume control superheterodyne, Chassis Model 127. The antenna bends into the position indicated by the dotted lines. Visual tuning is incorporated.

AN ANTENNA-LESS SUPERHETERODYNE

"HAPPY HOUR" and "Tenstrike," respectively, are the names of the new de luxe and table model Crosley superheterodyne receivers; the latter is illustrated in Fig. A. The same chassis is used in both. The schematic circuit will appear in a forthcoming issue of RADIO-CRAFT.

This new receiver design incorporates the latest advances in circuit design; it also establishes a new comparison for small-space construction of a receiver of exceptional sensitivity, and the numerous features which went to make up the former attractiveness of large radio sets.

Push-pull pentodes, visual meter-tuning, calibrated tuning, tone control, and automatic volume-control are included in this chassis, which bears the designation Model No. "127." Connections are provided for a phonograph pickup.

Perhaps the one item of foremost interest to most people is the "antenna-less" feature.

Of course, every technician knows that a radio set must have an antenna of some sort—some method of signal pickup, even if it is only an antenna binding post and its lead. However, for practical purposes the application will hold—for the antenna may be no more than a conductive sheet (painted cardboard) fitted within the cabinet; it is shown at the right for convenience in illustration.

This single feature is of tremendous importance to the small Dealer - Service Man, since he now can successfully combat the prospective customer's statement that they will not purchase a radio set because they will not permit unsightly antenna wires to be



Cabinet covers to save their finish.

strung inside and outside of the house. (Tests in New York City by RADIO-CRAFT technicians showed that in practically every case satisfactory reception now is possible with only an antenna plate for signal pickup.)

The following ten tubes are required for operation of this set: three type '35 or '51 variable-mu tubes, one of which functions as the first R.F., another as first-detector, and the third as the first stage of I.F.; one type '24 screen-grid tube, which is used as the second stage of I.F.; three '27's, one as oscillator, one as the diode second-detector, and the third as the first stage of A.F.; two type '47 or PZ pentode audio output tubes; and a single '80 for power rectification.

The audio level control, a potentiometer in the grid circuit of the first A.F. tube, is coupled to the diode detector audio output through a coupling condenser. This receiver is said to have what is known as "heterotonal response"; it is pointed out, further, that by correct use of the tone control it is possible to greatly reduce the acoustic effect of natural static. A dynamic reproducer is part of the instrument construction. A unique tube and tuning condenser shield, shown at the left of the cabinet has been developed for quick servicing. The instruments are manufactured by the Crosley Radio Co.

Thus it is seen that the new Crosley "Happy Hour" and "Tenstrike" 10-tube superheterodyne receivers are masterpieces of the radio craftsman's art.

AN ADJUSTABLE RADIO COVER

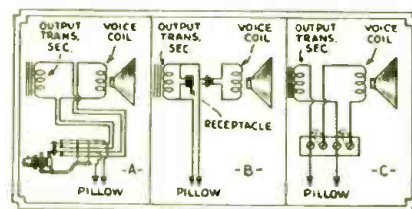

Fig. 1
At A, B and C, three methods of connecting the radio pillow into A.F. circuits.

resulted in the cabinet being damaged. The radio cover, pictured in Fig. B, was designed to eliminate this condition.

This new adjustable radio cover fits all standard cabinets and is equipped with two straps which enable the cover to be snugly wrapped around the cabinet. It is filled with layer cotton, evenly and heavily padded to form a cushion against hard knocks and jolting while in transit. It is a product of the Chicago Quilt Mfg. Co.

A RADIO PILLOW

IN Fig. C is illustrated the "radio pillow" which presents to radio

ONLY too often have dealers delivered a radio set and then sent a furniture polisher to fill in nicks, dents and scratches in the cabinet. In all probability, the cabinet was in good condition when it left the store, but during transit and carrying the set to the customer's apartment, the none-too-gentle handling by the chauffeur



Fig. C
The "radio pillow" in action; music at your ear's tip.

The latest devices are described here for the trade, Service Man, and home constructor. Watch this department for future developments in Radio.



Fig. D

Store-type tube tester having thirteen scales for direct reading.

men another means of fattening the pocketbook. Within the pillow, which is made of washable sponge rubber, is the reproducer unit—a standard head-phone unit; it connects to the radio set just like a standard head-phone. There is a small hole straight through the center of the pillow, as a sound exit whichever way the unit may face; a measure of volume control thus may be obtained by turning the pillow over.

The total weight of the pillow is 5 lbs.; it measures approximately 10 x 14 x 5 ins. thick. It is supplied with a white pillow-slip.

These pillows are sold on the recommendations that they may be used in hospitals, on radio-equipped trains, at home during the rest between rubbers of bridge or during favorite broadcasts, for the entertainment of the occupant of one twin bed, in radio-equipped hotels, and last, but not least, as a convenient means of individual enjoyment of automotive radio.

In Fig. 1 are illustrated several suggestions for connecting the "talking pillow" to the sound system.

This new boon to humanity is manufactured by RCA-Victor Co., Inc.



Fig. E

Above, an electric phonograph attachment for your radio set; the lid slides. At lower-right, the arrangement of the parts.

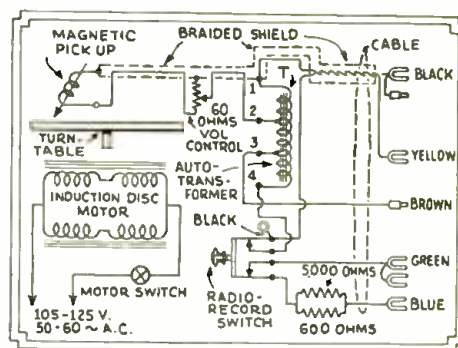

Fig. 3

Schematic circuit of the G.I. electric phonograph attachment for radio sets.

warrant consideration. An oversized meter having thirteen scales tells the customer the condition of his tubes. Each of the thirteen scales is graduated in three parts, indicating whether the tube under test is "satisfactory," "unsatisfactory," or "doubtful." Thus, the lay customer is not confronted with such technical terms as "milliamperes," etc., the meaning of which he does not comprehend.

The instrument is built in two types, the large model 538 and the smaller and less expensive model 214. The smaller model is provided with seven sockets, three for testing and four for preheating; all types of tubes including screen-grid and pentodes may be conveniently tested with the instrument.

A pilot lamp is provided which indicates when the tester is turned on.

All that need be done when testing a tube is to adjust the voltage-selector switch for proper filament voltage, reset the small indicating meter to zero with the reset control, and press the "Index of Merit" control button. The tube condition is readily indicated on the large scale of the tester without the necessity of computation or comparison with tube charts. To compensate for variations in line voltage, a resistance connected in series with the power line to the tester is made adjustable.

Only three of the seven sockets are shown for the sake of clarity.

The various resistor values may be calculated from the information contained in a series of articles by Clifford E. Denton entitled "Magic in Meters" (which appeared in past issues of Radio-Craft), or in the book "Radio Set Analyzers and How to Use Them," by L. Van der Mel.

These testers are manufactured by the Jewell Electrical Instrument Co.



Fig. F

Front view of the small-space "Wal-Tone" Radio set.

A TUBE TESTER FOR STORE USE

IN line with the tube-testing campaign that tube manufacturers are conducting in an effort to get the consumer to bring his radio tubes to the retail store to be tested, a new tube tester-seller, illustrated in Fig. D, has recently been placed on the market.

While the circuit diagram, shown in Fig. 2, is not radically new, nevertheless the tester has some very meritorious features that

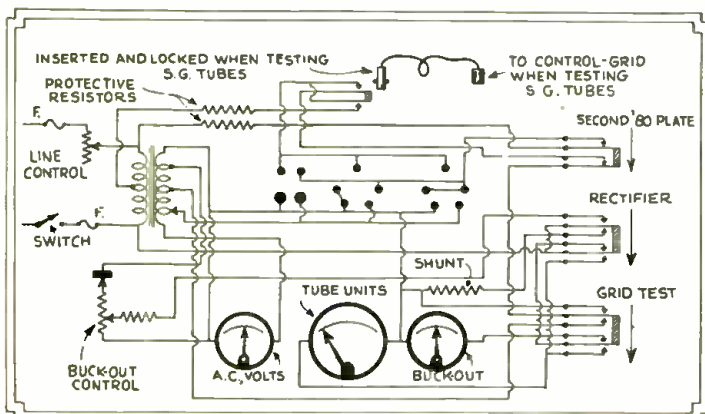

Fig. 2

Diagram of connections in the Jewell store-type tube seller.

(Continued on next page)

THE END-TABLE ELECTRIC PHONOGRAPH

ART and engineering have conspired to produce a new device—the sliding-top end-table phonograph; a commercial model is the pretty instrument illustrated in Fig. E, a unit which carries the designation of G.E. Model E-52 End-Table Phonograph. The schematic circuit of the device is shown for service reference in Fig. 3. This instrument may make any radio set a "phono-radio combination" (since it connects into the audio circuit of a radio set).

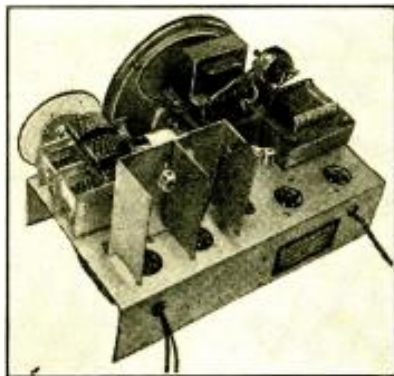

Fig. G

Upper chassis view of the Waltons miniature receiver. The complete shielding and the layout of the parts are well illustrated.

A radio-record switch is housed in the cabinet, enabling the listener to switch from one to the other without the necessity of moving to or from the radio every time a change is to be made.

The pickup is of low-impedance type with "inertia" damping. The assembly is designed for 110 V., A.C., and consumes 60 watts. The approximate dimensions are 25 x 26 x 13 ins. deep; the weight is 42 lbs.

If the set to which the instrument is connected should exhibit a tendency to oscillate (due to a poor ground), remove the phone tip from the brown cable lead and solder it to the spade terminal of the green cable lead. Also, place the other end of the brown lead on terminal No. 1 of the input auto-transformer T.

This decorative instrument, which may be placed anywhere within audio range of the associated sound system, is sold by the General Electric Co.

AN EFFECTIVE SMALL-SPACE RADIO SET

THIS seems to be an age of small receivers, if the interest shown by the general public is to be considered any indication. The miniature receiver illustrated in Fig. F, the circuit diagram of which is shown in Fig. 4, measures only 14 1/4 ins. in width, 9 7/8 ins. in height, and 7 3/8 ins. in depth. It employs four tubes, a '35, a '24, a '47, and an '80, and also uses a full-fledged dynamic speaker.

A view of the chassis, pictured in Fig. G, is an illustration of the manner in which the parts are laid out. An under-side view, Fig. H, shows the simplicity of construction, which is an important factor to the Service Man.

The values of the various parts listed in the diagram are as follows: Resistor R1, 8,020 ohms; R2, 1 megohm; R3, 25,000 ohms; R4, 6 megohms. Condensers C1, two-gang variable unit; C3, 8 mf.; C4, 4 mf.; C5, .1-mf.; C6, .02-mf.; C7, 16 mmf., C8, .006-mf. Transformers T1, an antenna coil; T2, an R.F. coil.

This receiver, the one and only product of the Walton Radio Corporation, is accompanied by the slogan, "The Mightiest Mite in Radio."

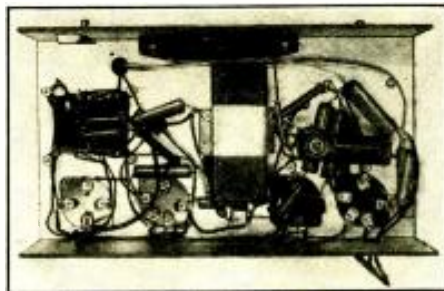

Fig. H

Under-view of the Waltons receiver. The layout of the parts are such that ease of servicing and replacing parts is accomplished.

A PORTABLE TUBE-CHECKER-SELLER

ELSEWHERE in this department there is described a tube checker suitable for store use, and now, to complete the line of tube-checking facilities, there is announced a tube seller, Fig. I, that may be carried into the home of the customer.

As in the previous checker, an oversized meter is employed, graduated in thirteen different scales, each scale corresponding to a given family of tubes. When a tube is being tested, the scale indicates whether it is "Satisfactory," "Unsatisfactory," or "Doubtful."

This type of scale is useful since the customer may readily comprehend its reading without being confused by technical terms.



Fig. I

This tube checker may be carried by the Service Man into the home of the customer.

A short-check circuit with four indicating lights is provided to test tubes for internal shorts. A line-voltage adjustment and indicating meter insures consistent readings despite line-voltage changes.

The Pattern "540" is housed in a leatherette carrying case, and by removing the cover it may be easily converted for counter testing when not in use outside the store. It is a product of the Jewell Electrical Instrument Co.

A SELENIUM PHOTOELECTRIC CELL

DURING the last year, several new photo-electric cells have been presented to the public. The trend in design has been toward simplicity in construction and increased versatility. As a means toward accomplishing this end, a new tube, known as the Radiovisor Bridge, illustrated in Fig. J, has been announced.

Unlike many of its predecessors, this new cell is not strictly photoelectric, since it depends for its action upon the change in resistance of a film of selenium which is placed over two interlocking comb-like electrodes of gold. When light falls on the selenium, its resistance decreases, the ratio of dark to light resistance for this cell being about 4 to 1. The Bridge is filled with an inert gas to increase its sensitivity, and is rated at .1-watt per square inch of light-sensitive surface.



Fig. J

The "Bridge" and its special socket.

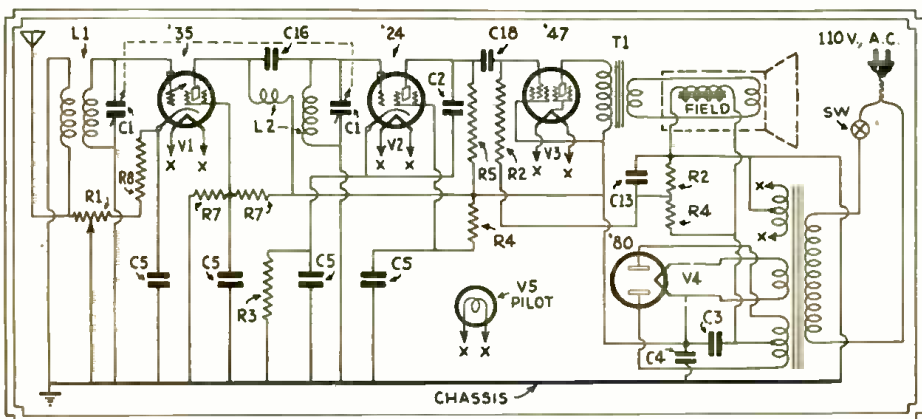

Fig. 4

Diagram of the Waltons receiver. It incorporates a dynamic speaker, a variable-mu in the R.F. stage, a '24 as a power detector, and a pentode output tube.

(Continued on page 490)

Dissecting A MODERN SET TESTER

(PART I)

In order to appreciate the efficiency of modern set analyzers, the author will, in a series of articles, discuss each unit of a modern analyzer separately.

By FLOYD FAUSETT*

IN the preceding issue of RADIO-CRAFT was described in a general way an up-to-date set analyzer, the Model AAA-1 Diagnometer. It is proposed to describe in greater detail, in this and subsequent issues, the several components which go into the make-up of this most modern of test devices.

On this basis, we find that the instrument contains the following units which, although they may be considered distinct in their action, are part and parcel of the operation of the set analyzer as a whole (that is, some service jobs will call for only one portion of the Diagnometer; while the other portions, perhaps singly, or in combination, will be brought into action on other calls):

1. Shielded Oscillator;
2. Set Analyzer;
3. Tube Checker;
4. Multi-Range Ohmmeter;
5. Capacity Tester.

The schematic circuit of the first unit, the service oscillator, is illustrated in Fig. 1; in Fig. 2 is shown a graph that represents the general type, one of which is furnished with each instrument, which is required to determine the frequency at which the oscillator is being operated.

This method of operation has been described in the July, 1931 issue of RADIO-CRAFT, page 10. Specifically, the oscillator incorporated in the Model AAA-1 Diagnometer has the following features:

1. Intermediate tuning range, approximately 90 to 550 kc., and regular broadcast range of 550 to 1500 kc.;

* Chief Engineer, Supreme Instruments Corp.

2. Adaptability for operation with ordinary 100-120 and 200-240-volt A.C. power supply potentials, with 100% modulation;
3. Completely shielded in cast aluminum tray, with bakelite-covered aluminum panel, and electrically isolated from all

as to maintain the proper impedance relations between the grid and plate circuits; and (2), to provide protection to the oscillator circuits against possible short circuits between the grid and plate elements. The fact that the modulation of most D.C. operated oscillators is about 30%, whereas the modulation of an A.C. operated oscillator is practically 100%, makes the Diag-

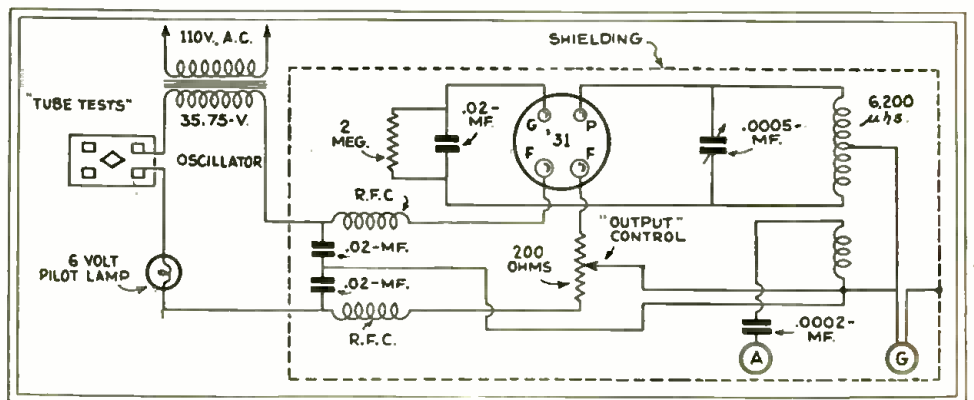

Fig. 1 Complete schematic of the .111-A oscillator. Modulation takes place at the frequency of the power supply, and does not depend upon the value of the grid-leak and grid-condenser.

power-supply circuits to prevent electrical shocks or damage to sensitive receivers;

4. Vernier-movement tuning dial for accurate-tuning control; and,
5. Regulation of oscillator output by manual control of the input potentials.

The unit is adaptable to all of the oscillator tests outlined in the radio manufacturers' service literature pertaining to radios which require readjustments.

Modulation Characteristics

Modulation of the R.F. signal of the oscillator is automatically accomplished by the A.C. power supply, so that the output signals of a radio receiver coupled to the oscillator will have an A.F. "pitch" corresponding to the frequency of the power supply system. The resistance and capacity values of the oscillator are such that practically no grid-leak modulating action results; instead, modulation is accomplished by the A.C. power supply.

It is the purpose of the grid resistor and capacity combination: (1), to provide the proper grid bias for the oscillator tube so

nometer oscillator very adaptable for adjustments of modern radio sets in which the blasting effect of strong signals is minimized by volume level circuits which are most efficient when operating with signals from a 100% modulated broadcast station.

If strong R.F. signals are applied to a sensitive receiver of this type by an unmodulated oscillator, it is possible to overload the detector with R.F. energy without having any appreciable loud-speaker output of A.F. energy. In some sets, an overloading of these circuits with R.F. energy may result in two output peaks, and in broad tuning, when the modulation is considerably less than 100%. It is, therefore, obvious that the loud-speaker output is greatly dependent upon the percentage of the modulation of the input R.F. signals.

When first connected for operation, the oscillator tube shield between the "Type" and "31" panel markings should be removed and a type '31 tube inserted in the oscillator tube socket before replacing the shield. The procedure for the operation of the
(Continued on page 490)

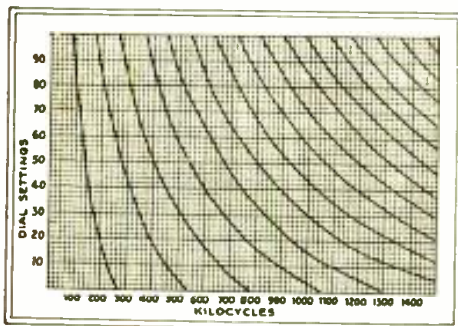

Fig. 2 Calibration chart of the Supreme AAA-1 oscillator.

A Gooseneck-Type

VACUUM-TUBE VOLTMETER

By BERYL B. BRYANT

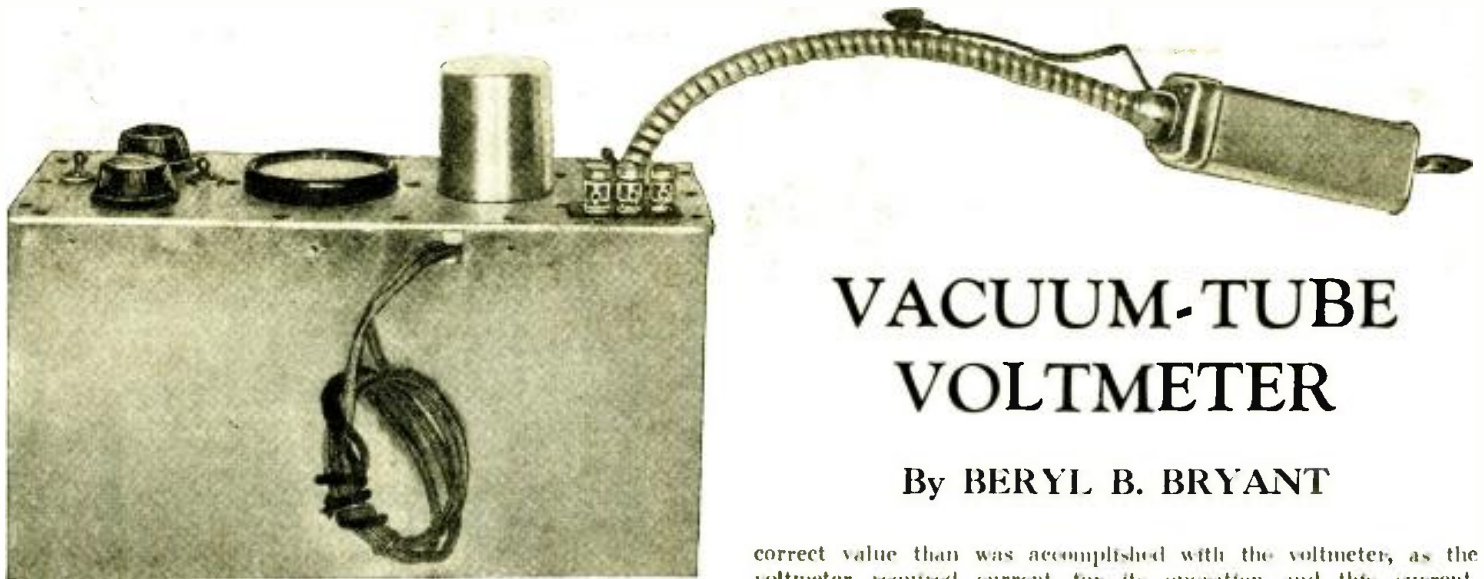

Fig. A

External view of the shielded Gooseneck V.T. voltmeter.

EVERY art, every work, has its special tools, else the artisan could not accomplish his various tasks. The tools of the radio engineer are delicate and sensitive measuring instruments. Of all the measuring instruments employed by the progressive engineer and technician, none can surpass the vacuum-tube voltmeter in its vast and diversified uses. While it is not the purpose of the writer to expound to any great extent on the subject, it is believed that many employed in the art of radio are not familiar with the instrument and its uses, else they would not be disrupting their nervous systems in the operation of instruments which are a college professor's delight but not conducive to production in a busy laboratory.

The term "voltmeter" has naturally lead many to believe that the instrument is useful only for measuring voltages. This is erroneous, as the device may be used to make other measurement indirectly and, in addition, has the characteristic of no power consumption from the device or apparatus under test, as is the usual case with the ordinary service voltmeter. A case in point; how many have measured the voltage on the screening-grid, which has its potential fed through a series resistor, with the ordinary 1000-ohm-per-volt voltmeter, adjusted the voltage to normal, and still have the stage persist in oscillation, yet by varying the voltage on the screening-grid the oscillations would be overcome? Performing the latter operation, the voltage was adjusted more nearly to the

correct value than was accomplished with the voltmeter, as the voltmeter required current for its operation and this current, though minute, was sufficient to alter the correct reading. Had the potential been measured by a vacuum-tube voltmeter, the potential could have been adjusted to the correct value, since the grid of the vacuum-tube voltmeter requires no current for its correct function. On the contrary, if current be made to flow in the grid circuit, inaccuracies will result as the tube will no longer possess a linear characteristic.

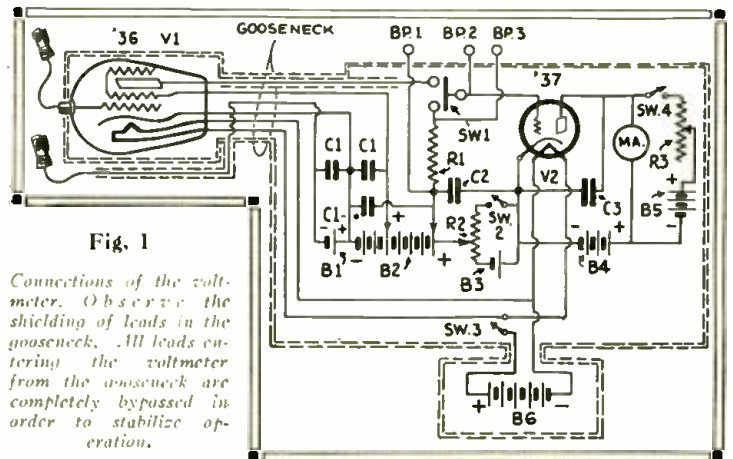

Fig. 1

Connections of the voltmeter. Observe the shielding of leads in the gooseneck. All leads entering the voltmeter from the gooseneck are completely bypassed in order to stabilize operation.

Measurements Possible

A few of the measurements which may be accomplished with the vacuum-tube voltmeter are: field-strength measurement, percentage of modulation measurement, measurement of large and small resistors, inductors and capacities, measurement of both radio and audio frequencies, amplification at radio and audio frequencies, power output, hum measurement, distributed capacity of coils, mutual inductance between coils (coefficient of coupling), and audio frequency characteristics of loud-speakers. Most of these measurements are not made with the instrument alone, or may not be direct measurements, it is true, but the labor involved by using a vacuum-tube voltmeter set-up is far less and, as mentioned above, more accurate than with most other systems of measurement.

With these things in mind, in addition to other problems which experience with other types of vacuum-tube voltmeters had taught, the writer wished to design and construct an instrument that would not cost a fortune and would have a high accuracy. It is possible to construct a single tube vacuum-tube voltmeter which will measure small potentials, but the cost of the low-range microammeter used with such an instrument is prohibitive to users other than large

(Continued on page 492)

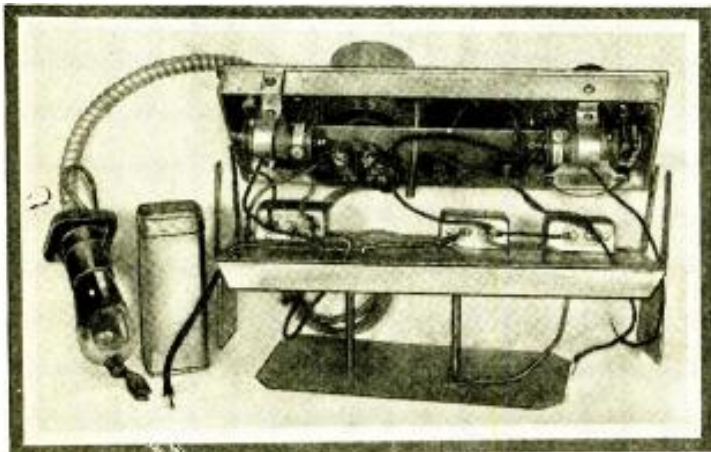

Fig. B

Internal view showing the layout of the parts.

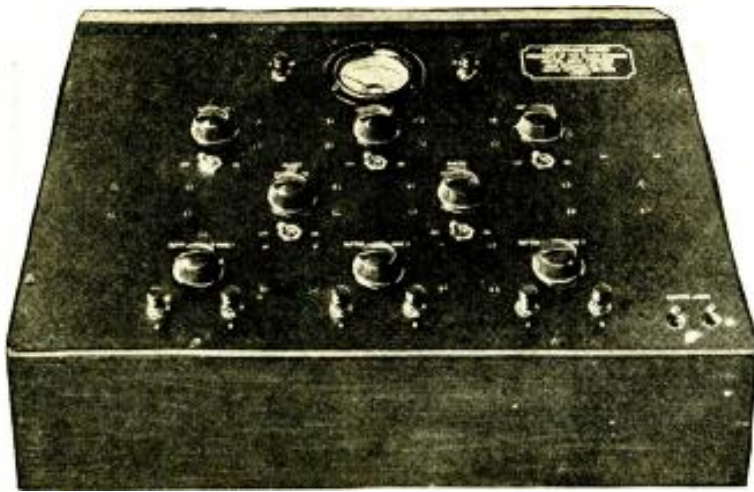

Fig. A

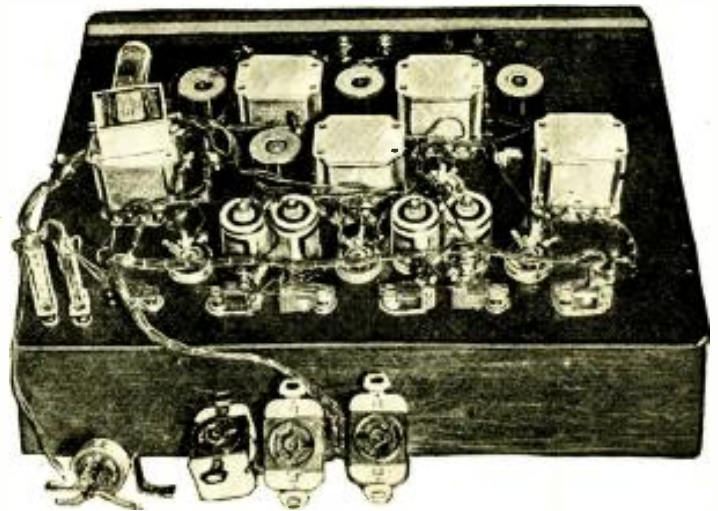

Fig. B

HOW TO MAKE A MICROPHONE MIXER

(PART VI)

Although designed for a big hotel, this "mike" mixer is adaptable to other requirements

By ELI M. LURIE, B.E.E.

ONE of the most profitable fields for the radio Service Man and dealer is one that is comparatively untouched by these individuals. It is, however, not because they have not tried to do public address work, but rather because of the mediocre and unsuccessful results obtained in the operation of such systems even when the quality of the apparatus used was considered excellent.

Why then, you ask, were the results poor when the materials used were excellent?

Naturally, the amplifying equipment used for public address work must be good but barring this single item, the most important reasons why this work has been unsuccessful are directly due to two troubles almost always overlooked. These are:

1. The use of carbon button microphones working at overloaded conditions.
2. Improper impedance relation between component parts, both inherent and through use of improper attenuators.

In the first case, if the sound projectors

are operated so that the issuing sound is in the path of the "mike," then there will generally be an abundance of feed-back. This is especially true in large bare halls in which echoes predominate. To compensate for the feed-back, the operator will usually cut the gain but—and here is where the difficulty is—as soon as the amplifier gain is reduced, the sound output is likewise reduced and in an attempt to again bring the gain up to a point where the level is satisfactory, the speaker will raise his voice and shout into the carbon microphone.

The immediate effect is noticed as extremely poor quality which is directly due to the microphone being overloaded. Thus, through no fault of the amplifier, the general opinion is that it is the amplifier that is at fault.

To eliminate such a condition, it is necessary to arrange the sound projectors so that the output is projected away from the "mike." This is not always easy, but it is far better to spend considerable time finding a suitable arrangement where the amplifier and not an overloaded "mike" will supply the necessary output, than it is to have a failure with the resultant loss of future business.

In a large hall or auditorium, the best plan is to use only one projector facing the audience with the microphone behind it. If this isn't possible, then the projector can be placed directly above the microphone. If more than one projector is used, echoes may be created with the resulting feed-back. Remember, it is not necessary to have the

(Continued on page 496)

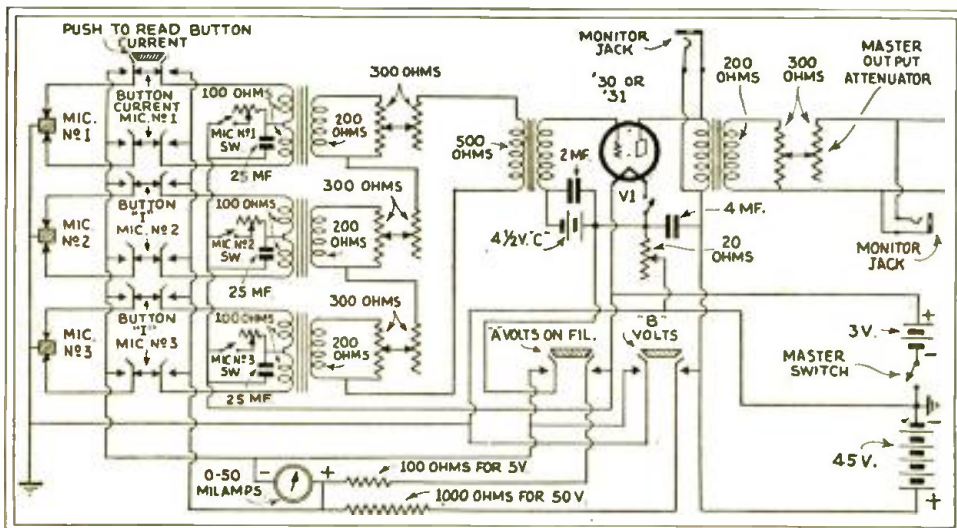

Fig. 7

Schematic diagram of the microphone mixing panel illustrated in Figs. A and B, above. Exceptional care has been exercised to obtain correct matching.

How to "SYNC" Disc AND Film

By HERBERT C. McKAY

ONE of the first things which the amateur thinks of after his early success in home recording, is making talkies at home. After all, the talking picture is nothing more than a combination of motion pictures and a phonograph. There is no reason why the ama-

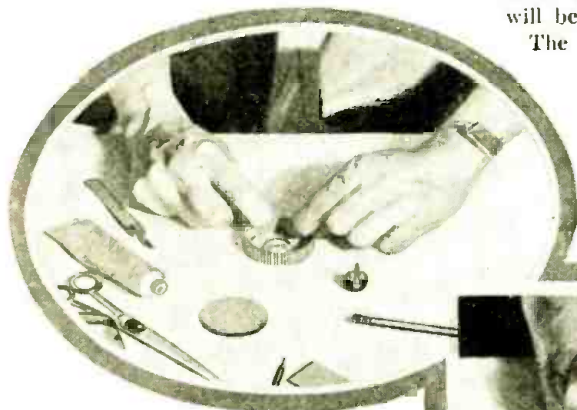

teur who has a recording machine should not make sound additions to his home-movie films which will be entirely satisfactory.

Sound, which is used to accompany motion pictures, is of two kinds. There is that which is recorded synchronously with the action and which constitutes the true "talkies." This type of sound is not suitable for amateur use. The technical difficulties could be overcome, but the trouble lies in the fact that the actual sound which accompanies the usual home-movie making is not worth while recording. It may be surprising to learn that in professional work there are far more difficulties encountered in producing the right sound than there are in recording it after it is produced. For this reason, synchronous recording is definitely not advised for amateur experiment.

The sound which is added to the picture after it is completed is a type of sound which is far better for the amateur's purpose, and one with which he can do much that is really worth while. There are two ways in which this sound may be used.

The first is the imitation synchronism or "lip-matching." In this work, the film which is to be matched is projected time after time with the speaker speaking in synchronism with the film until by repetition he has gained the ability to speak in strict unison with the subject shown upon the screen. When this can be done smoothly and accurately, the record is made. If there are no accidents, a very good match will be secured.

The second type of sound, and the one which will no doubt appeal most to the amateur, and the one which is most appropriate to the average amateur film is the sound which is used as an accompaniment. In this type of sound recording, we use certain effects;

- Fig. A, right.
Laying out the divisions.
- Fig. B, above.
Marking the black divisions.
- Fig. D, left.
Assembling the stroboscope.

wind, rain, the surf, gun shots, automobile or airplane motors, galloping horses as well as incidental speech which is not timed to the actor's lips. This is effective and easy to record.

Speed Ratios

It is of course necessary that in order to do any of this work that the projector and the phonograph run at speeds which maintain a certain ratio to each other. That is they must run in approximate synchronism.



Fig. E

The completed stroboscopes for both disc and projector are shown above. They should be watched while recording.

If there is an error amounting to even as much as twelve frames at the end of the film it is all right, so we may say that the synchronism necessary is only approximate.

Before describing the manner in which this is effected, some space should be devoted to a discussion of the ratios which are used in motion picture work.

Professional talking pictures are exposed at the rate of 24 per second or 1440 frames per minute. This is a film speed of 90 feet per minute. The record used for disc synchronization, revolves at a speed of 33 1/3 revolutions per minute. Thus the ratio is usually spoken of as 1440-33 1/3. This is obviously 4320 to 100, or 43.2 to one.

The usual home phonograph operates at a speed which approximates 80 revolutions per minute and the home recorder is usually made to match. The first machines

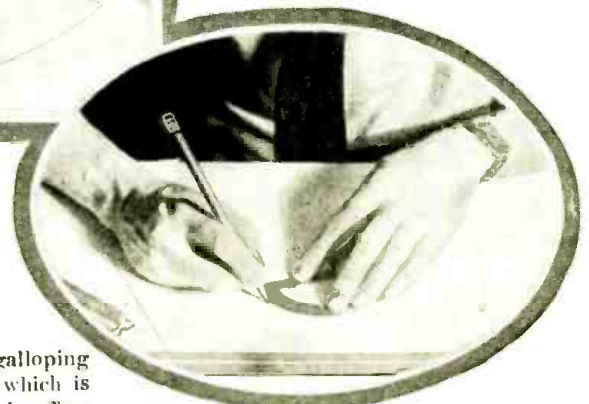
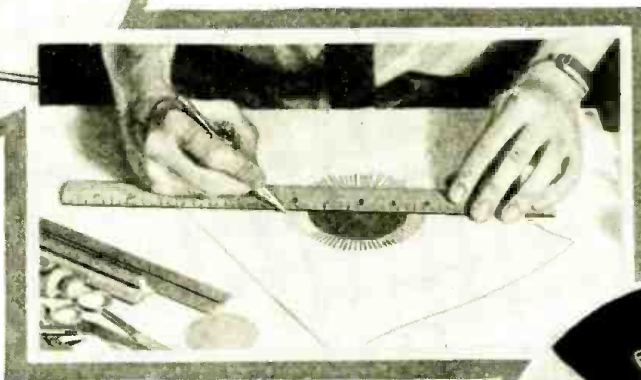

for showing talking films in the home were made to use the standard commercial record which is played at 78 or 80 revolutions a minute. However, for some reason best known to themselves the manufacturers adopted a two to one ratio. The sprocket feeds eight frames in one revolution, a
(Continued on page 499)

The RADIO CRAFTSMAN'S

The Bulletin Board for Our Experimental Readers

Page

MORE ABOUT THE STENODE

IN an interesting discussion regarding the "Stenode Radiostat" (which appeared in the November, 1931 issue of RADIO-CRAFT) carried on between Dr. Robinson of the British Radiostat Corporation and Mr. Clyde J. Fitch, several important questions were raised. The "Stenode" has created such an enormous amount of discussion, that RADIO-CRAFT has decided to reprint in full Dr. Robinson's reply to Mr. Fitch.

Readers are requested to read the above-mentioned issue of RADIO-CRAFT before proceeding.—*Editor.*

DR. ROBINSON'S REPLY TO MR. FITCH

Editor, RADIO-CRAFT:

Mr. Clyde J. Fitch, in an interesting letter in your November issue, raises some questions about the theory and practice of the "Stenode," on which your readers would probably like to have my views. Mr. Fitch's letter originated out of some comments of mine on a former article by him in which he had suggested that the functioning of the "Stenode" might have some connection with accidental frequency modulation of broadcasting stations, and it is of great interest to see that, in his opinion, there is now no doubt that the "Stenode" reproduces the modulations of a transmission even if there is no frequency modulation present. Now that this very important point has been removed from the field of controversy, it is of great interest to see how Mr. Fitch puts his finger on other

points just as important, and which need some elucidation. I shall take these points in turn and attempt to make them clear for your readers.

1. *What Selectivity does the "Stenode" really give?* Mr. Fitch says it is difficult to see what gain is obtained in the "Stenode" by employing very high selectivity and then correcting in the audio stages. How can this give any better results than the usual 10 kc? He brings forward this question in an admirable manner, and although he himself has not answered it theoretically, he is at pains to describe the excellent results from this point of view which he obtained with an actual "Stenode."

For years now, the aim of designers has been to obtain as perfect a high-frequency curve as possible to give equal response over a 10-ke. range, and with no response at all outside of this range. In fact, designers had sought for a resonance curve which shall be square topped, with vertical sides, and have an absolutely uniform response over 10 kc. The methods employed have almost universally been of band-pass types, and the results have usually been to give a wavy top to the curve or one with maximum and minimum, whilst the sides have not been vertical.

The first feature of the "Stenode" in this connection is that it enables us to obtain the equivalent of this ideal 10-ke. response curve, one whose top is flat, and whose sides are nearly vertical. This is achieved by using a circuit of great selectivity such that the modulation effects are inversely proportional to the modulation frequency, and then to employ a low-frequency amplifier whose amplification factor is directly proportional to the frequency. Then if we are only concerned with a 5-ke. audio response, we arrange that the audio amplifier begins to cease functioning at 5 kc. Hence, from the purely design point of view, the "Stenode" gives the ideal solution to the present day selectivity problems.

The second feature is that from its functioning, a very much better result as regards interference is obtained than most people expected, for in fact the possibility is introduced of reducing interference from neighboring stations to an undreamt-of extent. Let us consider the case of two neighboring stations 10 kc. apart. Owing to the very high selectivity, we have very desirable effects at the rectifier which precedes the audio corrector and amplifier. In the first place, when we tune to one of the stations, we produce a large amplitude of the desired carrier, and a very low amplitude of the interfering carrier. Secondly, we have

the fact that the desired carrier, has had its percentage modulation reduced, so that at the rectifier we have normally a desired carrier wave with a large amplitude, and having a low percentage of modulation, together with an interfering carrier of very small amplitude, which however is also modulated. Then, normally, we shall have to employ such grid bias at the detector that the desired modulations occur on the straight portion of the rectifier characteristic, thus giving us linear rectification.

The conditions are thus suitable to take advantage of an effect in radio not yet well known, called "Detector Demodulation." I indicated in a paper I read before the Radio Club of America, that the "Stenode" makes use of this effect, and it is very interesting to note that, since that time, there have been some papers written to give a clear explanation of it.

Demodulation Effects

This demodulation effect is that when a linear detector is employed, and when there are present a strong and a weak carrier, both modulated, the strong carrier demodulates the weak carrier when the heterodyne effect is supersonic. The extent of this demodulation depends on the relative strengths of the two carriers, and as the ratio of strong to weak carrier increases, the modulation of the weak carrier is more and more absolutely reduced. This effect was discovered by Beattie and later elaborated by Butterworth.

Obviously, the "Stenode" produces the conditions just described. The high selectivity makes the desired carrier strong and the interfering carrier weak. Linear detection is almost unavoidable, and we can arrange to make our audio circuits and instruments reject every frequency above any predetermined value. Thus, if we choose 5 kc. as our desired limit, an interfering carrier at 10 kc. gives an inaudible heterodyne effect, and thus has its modulation reduced to a negligible amount.

We can go still further than this, and if we bring the interfering carrier nearer to the desired carrier, say to $5\frac{1}{2}$ or 6 kc., it is also demodulated, as the heterodyne effect is still inaudible. This is obvious because the theory of demodulation as worked out by Butterworth is perfectly general, and independent of the frequency separation of the carriers, so long as the heterodyne effect is inaudible or supersonic to our acoustic circuits or instruments.

(Continued on page 501)

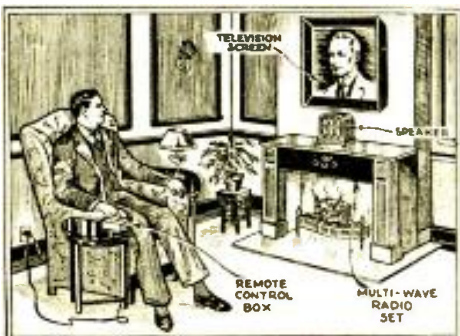

The television receiver of the near future. Remote control buttons are used to select any type of picture with its accompanying sound. A suggested layout is shown here.

PUSH-PUSH RECEIVERS

Two interesting receiver designs, one for operation on battery power, and the other on 110 V., D.C., are described by the author.

By C. H. W. NASON

ALTHOUGH it may at first be thought that the push-push amplifier (described in the January, 1932 issue of RADIO-CRAFT) has its major value in the field of high-power amplification, a little study of the subject will show that this is not quite true. The writer shows in two of the accompanying figures just how the system is valuable in the lowest powered equipment in the radio field: the direct-current operated receiver; and the dry-cell powered receiver which may be employed in rural districts where power systems have not as yet penetrated, or on boats, where it is the most economical form of operation.

The most satisfactory tubes at present available for use in the D.C. set are the new automotive types with 6.3 V., 3-A. filaments. We have the single '38 pentode available with a power output of 200 milliwatts; or about 500 milliwatts in push-pull. Now let us see what the little '37 "general purpose" tube will do for us in the PUSH-PUSH connection. In Fig. 1, there are shown the curves of the '37 operated as a push-push amplifier with a plate voltage of 100 and a negative grid bias of 7 volts. The load impedance at which the curves

A grid swing of 40 volts is necessary,—readily available with a similar tube in the first A.F. stage working into a low ratio interstage transformer such as is necessary in push-push operation because of the grid current drawn.

A transformer for the output coupling will be difficult to find because of the small load required. We may, however, employ a transformer designed for use with the '45 tube instead, with a small sacrifice in the output power obtainable. The power will still be far in excess of that obtained with the two pentodes in the push-pull connection. In Fig. 2, there is shown the circuit schematic for a D.C. receiver employing these tubes. The receiver is self explanatory in so far as the other circuits are involved.

The Battery-Operated Receiver Assumes The Push-Push Role

With the battery-operated receiver, we would normally employ the '31 with a power output of 150 milliwatts at 135 volts and a plate current of 6.8 ma., or about 400 milliwatts with a plate current of 13.6 ma. in push-pull. These tubes have the disadvantage of requiring a filament current of .130-amp, whereas the associated tubes of the 2-volt line take but .06-amp. There is also a pentode output tube incorporated in this line but having a filament current rating of .260-amp,—more than four times the drain on the batteries imposed by the general purpose tube of the line—the '30, and with a possible power output in push-pull of 1200 milliwatts or so. The filament consumption of the tube renders it unsuited for use with the air-cell battery—the drain for two tubes in push-pull being more than a half ampere for the filament current and
(Continued on page 503)

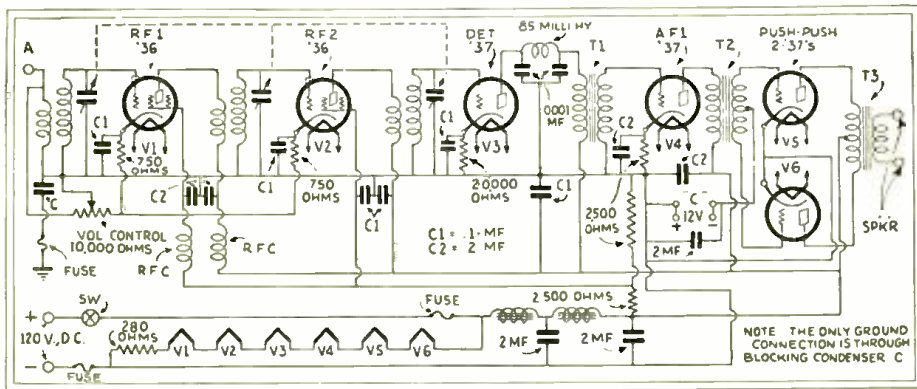

Fig. 2

Schematic circuit of a receiver designed for operation on 110 V., D.C. "General purpose" '37's, 1'5-1'6, develop 1,200 milliwatts output.

Let us consider first the power output usually available in the receivers of these classifications so that a standard of comparison may be established. The D.C. receiver usually employs either two '45's or four '71A's in its output circuit. Either method of operation is wasteful of power because of the high filament current required, but particularly so in the case of receivers using the '45. The power output available is about 700 milliwatts from two '45 tubes operated in push-pull with a plate voltage of only 100. Four '71A tubes in a parallel push-pull structure can deliver about equal power without distortion. In the case of the battery-operated receiver, we have, in the two-volt classification, the '31 tube which will deliver at 135 volts about 150 milliwatts per tube; or about 400 milliwatts in push-pull. Two '31 tubes draw a total of 13.6 ma. from the "B" batteries.

The Push-Push Amplifier and the 110-Volt D.C. Receiver

Let us consider the advantages to be gained from the push-push amplifier in either of these receivers. First we will take the D.C. receiver such as is necessary in certain metropolitan areas,

are taken is 1500 ohms. If we employ the data given in the last issue of RADIO-CRAFT we will arrive at the conclusion that a possible power output of 1200 milliwatts is available—more than twice that available with the power output pentodes of the 6.3-volt line!

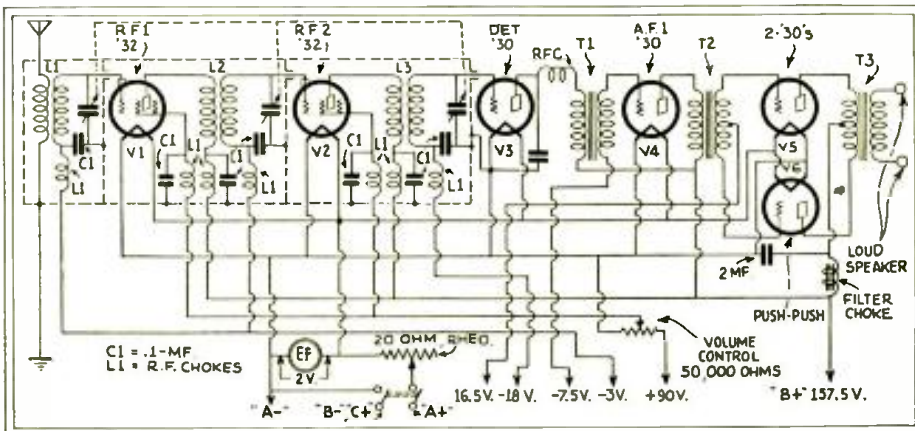

Fig. 4

Diagram of connections for incorporating "push-push" power amplification in a battery-operated radio receiver. The "general purpose" '30's, 1'5-1'6, develop 1,000 milliwatts output.

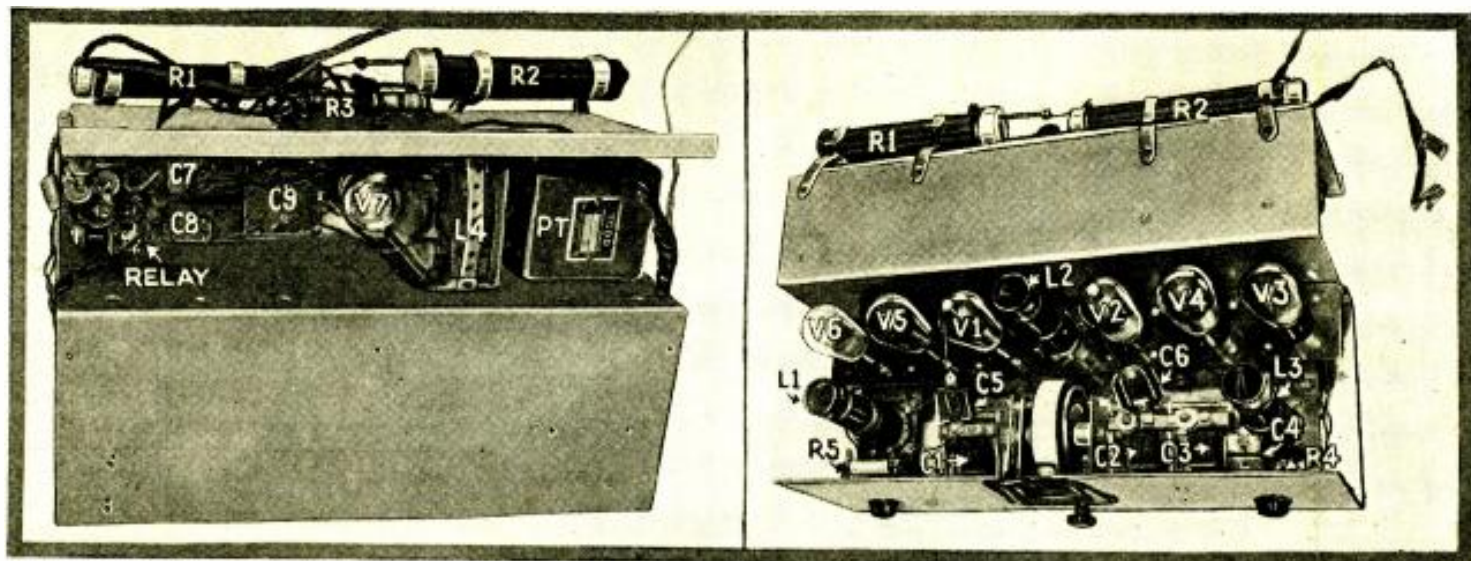

Fig. A

Underside view of the chassis of Mr. Poncel's A.C.-D.C. convertible radio receiver.

Fig. B

Looking into the relay-controlled electric receiver. Just plug into the power outlet.

AUTOMATIC A.C. D.C. OPERATION

A relay automatically changes the circuit for 110 D.C. or A.C.

IN past issues of RADIO-CRAFT there have been described various receivers that may be operated directly from both alternating and direct current. These receivers all have some form of switching arrangement that must be manipulated when changing from one type of current to another. In the receiver to be described, operation from either A.C. or D.C. sources may be effected without the complications that usually accompany switching arrangements. The finished receiver, a patent for which has been granted, is illustrated in Fig. A, and a top view shown in Fig. B. These show the general arrangement of the parts.

General Theory

An examination of Fig. 1 will reveal the general method by which universal power operation is secured. The winding W of a high-impedance induction coil T1 is connected directly to the line plug. If the source is D.C., then the current that flows through the winding pulls the arm A against

By ALEXIS PONCEL

the tension of the spring S, making contact with a stationary contact 2. This places the D.C. line directly into the filter unit, the positive terminal to the plates of the tubes, and the negative terminal to the filament circuit which will be described later. If the

source is A.C., then the amount of current flowing through the winding W is not sufficient, due to its high impedance, to cause the arm to pull over. The result is that the arm A makes contact with stationary contact 1, and the A.C. is applied directly to the primary of the power transformer PT. Thus, the switching is done automatically and the installer need not worry about the type of current available.

The telephone repeater coils are inserted in series with the electromagnet in order to increase the impedance to the flow of A.C.; their resistance is not sufficient to affect the operation on D.C. The rectifier may be either of the gaseous type, as shown, or of the '80 type.

The Filament Circuit

Only one other part of the circuit needs comment—the filament circuit. Since the filaments are connected directly across the line, it was found necessary to connect the negative "B" return to the geometric center

(Continued on page 504)

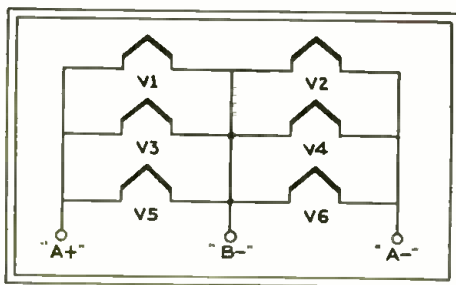

Fig. 2

Filament circuit of the receiver.

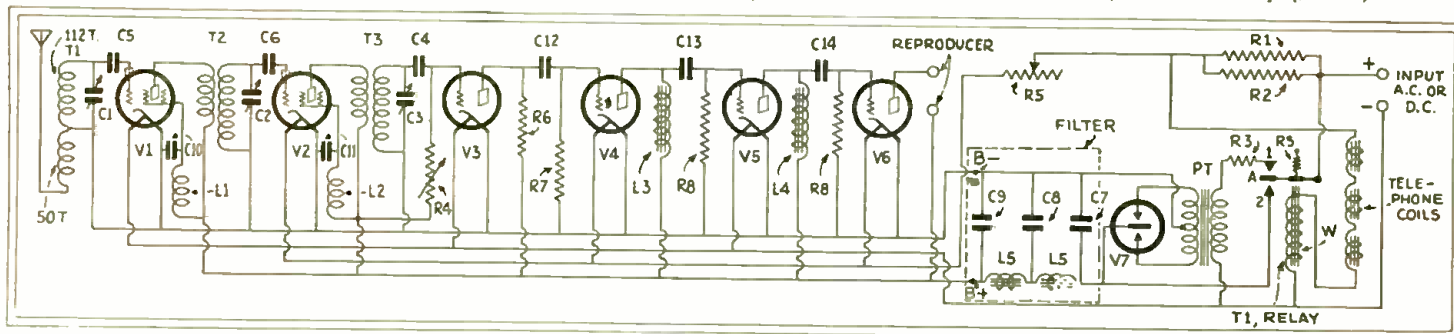

Fig. 1

Schematic circuit of the convertible radio set. Arcturus tubes are indicated by the symbols. Although shown without grid resistors, it may be necessary to return the grids of tubes V1 and V2 through leak resistors of about 1 meg. rating. V3 is the detector. The relay T1 automatically selects the correct circuit arrangement for operation on alternating or direct current lines. This principle of operation is readily adapted to other tube and parts arrangements.



RADIO SERVICE *and*

|| “—Radio men—work too fast.—Radio will receive from the set and the cost at box office prices, should not begrudge the money certificates of approval on their radio installations same as they get when they do any other wiring We do not quarrel with any man’s right to make a

|| life and property of himself and others, civilized life demands that this man be subject
New York Board

By GUS JACOBSON

(PART

MOST electricians in the building trade, or in jobbing and maintenance work, hold the radio Service Man in low esteem. The reason for this viewpoint becomes apparent immediately comparison is made between the length and character of the training required by each, before the term “mechanic” is applied to him. Also the higher wages paid in the electrical industry have had an important effect in bringing this condition about.

Actually, the average Service Man knows more about electricity than does the journeyman electrician. In the writers’ twelve years as master electricians, we doubt whether half of the electricians employed, can solve for resistances in parallel. Those who could, usually totaled up all the currents in all the resistors and divided this into the voltage. Possibly one mechanic in ten could explain why, in an Edison three-wire system, failure of a neutral fuse would gradually burn out all the bulbs on one side of the line and cause all the bulbs on the other side to grow dimmer and finally go out altogether.

Yet, we must rate the electrician as the better mechanic. In the final analysis, the radio set owner pays the Service Man, not for the contents of his head, but for the actual physical work done upon that radio by his hands, assuming that the Service Man knows his theory. Since most of this work is done with tools, the quality of the net result will depend upon how well trained in the use of tools, the Service Man’s hands have been.

It is highly regrettable that radio has no training period comparable with the mechanic and helper stage in the electrical industry. While the radio man has to “dope out” the fundamentals for himself, the electrician helper starts work with an experienced mechanic who will usually pass on to the helper, all the work he can. To get this work done properly, he must explain the *how* and usually the *why*. Further, the helper, in the beginning, seldom has his own tools and works with the mechanic’s, and the latter is pretty apt to insist upon these tools being properly handled.

The “Electric Code”

Lastly, the electrician does not depend upon his conscience to guide him. His work must conform to the regulations of the National Electrical Code and municipal Electrical Codes.

Electrical work is subject to much stricter regulation than any other branch of the building trades simply because wherever it is used, electricity always carries with it the menace of fire. Since the financial losses of most fires are covered by insurance companies, bodies of persons qualified by training and experience to study the causes of past fires and form rules for the prevention of future fires, have been organized by these insurance companies and are known as Fire Underwriters. The Electrical Code is the result of the thousands of investigations and radio Service Men will do well to heed its regulations.

At this point, a few words of warning to employers of Service Men, are in order.

They are responsible for the actions of their agents. Action for damage to property while installing radio sets will be brought against them, not against the Service Man. If the cause of a fire can be traced to their installation, for which they cannot produce a written certificate of approval, action may be taken against them. Further, if there has been injury to persons or loss of life in the fire, this action will be on criminal charges. The laws covering electrical installations or repairs to electrical installations or appliances are, for legal wording, usually simple.

We quote from the New York City Municipal Code, Chapter Nine, Code of Ordinances:

“Article 1, Section 6. No person shall install, alter or repair, or cause to be installed, altered or repaired electric wiring or appliances for light, heat, or power in any building except a person holding a license, a special license, or a permit as defined in Section 1 of this chapter, or a person employed by and working under the supervision of the holder of a license, a special license, or a permit.

“Section 12. No person shall supply, cause to be supplied or used, electric current for light, heat or power to any wiring and appliances in any building until a certificate temporary or final, authorizing the use of said wiring or appliances, shall have been issued by the commissioner.

“Article 5, Section 501. (h) Wires shall not be fastened with staples. (i) Twin wires shall not be used, except in conduits. . .

“Article 6, Section 611. (c). All splices and joints in conductors shall be made both mechanically and electrically secure without solder. The splices or joints shall then be soldered unless an approved form of splicing device is used, and shall be covered with insulation equal to that on the wire. (j). Where exposed to mechanical injury, wires shall be suitably protected.”

Thus we see that radio installations in New York City must only be done by licensed electricians or their employees. In the exact meaning of the law, no radio set may be used without first being approved by the Commissioner of the Dep’t of Water Supply, Gas and Electricity. Service Men, therefore, have no “divine right” to install or repair radio receivers in any manner they wish and, unless their “bosses” are licensed electricians, are continually violating local ordinances in the performance of their work.

How long this condition will last, depends entirely upon the character of the work that Service Men turn out and it is the writers’ belief that the present grade of work is not good enough to maintain this state of affairs, and we believe that the time is drawing near when radio Service Men will be compelled to take out licenses to prove their ability, the same as electricians, plumbers, chauffeurs, motion picture operators, or members of any

the ELECTRIC CODE



set buyers, figuring the entertainment they get to them if they were to buy this entertainment for a decent job. If they were to demand and get as both the law and their insurance policy direct, the both they and the radio Service Man will be the gainer, living, but when this method involves possible danger to whatever rules are found necessary to minimize this danger." Mr. Corlies,

and DAVID COHEN

I)

other trade where lives and properties of other persons may be endangered by carelessness or ignorance.

Inspection a Selling Point

Several large department stores and a number of other radio sales organizations have long ago taken steps to avoid any trouble for their customers from fire authorities. With each radio sale, an installation charge is made and certificates from both Underwriters and City Electric Bureau are turned over to the customer. In such cases, radio set owners can look at any inspector without fear, trembling and worry about possible violations.

Now, of course, will come the loud and dolorous cries of the men guilty of the flexible cords tacked to walls and spliced under canopies, "the others are connecting up radio sets the same way and we must meet competition. Customers won't pay for a decent installation."

That is not the truth. Armored cable does not cost much more than flexible cable. The trouble is these men do not know how to do the work without ruining entire ceilings or walls. They haven't the tools to fish BX, most of them do not even know how to cut BX, they do not know how to mix plaster and patch up the few holes that may be necessary to open in walls. They do not know whether plugging in a radio will overload a circuit or not, yet they will speak sagely of their high standing in the radio industry.

It is a peculiar fact that men of this type get higher prices for repair jobs than good men who really know what is wrong with a set. Subconsciously knowing that they may have to spend much time at the bench before actually finding what is wrong with a set, or that they may have to turn it over to some other man to fix, they have a standard diagnosis, "Burned out condenser block," and they show the set owner a list price of \$16.93 or \$14.87; some radio organizations prize high price getters like this.

A City Inspector Speaks

Mr. Whittaker of the New York City Bureau of Gas and Electricity and Mr. Cawley of the New York Board of Fire Underwriters take in the district bounded by

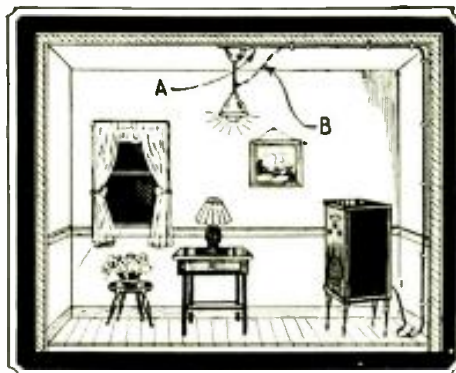

Power taps under canopies, A, or to drops, B, are not "code wiring."

Fifth Avenue and the East River in the Fifty- and Sixty-Numbered streets in New York City. Since 711 Fifth Avenue, Park Avenue, and the East Side are included in this district, these men are able to speak from experience on radio for extreme wealth and extreme poverty; and also on a real job as exemplified in 711 Fifth Avenue, the home of stations WEAJ and WJZ.

Mr. Whittaker says, "To me, it seems that radio men do not realize the serious consequences that may result from a bad installation. Just as surely as the man who drives an auto without any brakes, or the man who pumps gasoline with a glowing cigarette in his mouth, the man who tacks silk cord along a base, up a wall, and under the canopy of a fixture, is courting trouble.

"Ignorance of the law cannot be recognized as an excuse for its violation. As this principle is not peculiar to the electrical code, but is recognized by all governing bodies, a radio Service Man cannot take refuge behind the excuse that he didn't know this or that was a violation.

"The most common condition that I find, seems to be that installation does not receive the attention it should at the time of sale of radios. If the buyer wishes to have the radio placed in a certain position in a particular room and there is no base or wall receptacle there, why is that the fault of the firm selling the radio? Yet that seems to be their viewpoint and they will send a man up to connect the radio in as cheap a manner as possible.

"If the buyer wishes the set in any particular location, I don't see why he or she shouldn't go to the expense involved in having the job done in an approved manner. If there are no receptacles, the radio or other appliance bought by the tenant has caused the condition of its being needed to arise. A little courage on the part of the salesman who would take the trouble of explaining this to a customer, would certainly make way for better installations.

"Receptacles wired from fixtures with flexible cord, motor generators placed in closed, unventilated closets, and usually with a lot of clothing and other combustible material thrown over them, splices made by merely hooking or twisting two wires together, without solder or without rubber tape, gas pipe used as a ground,—these are violations and must be 'written up' wherever found.

"It is false economy on the part of any radio dealer to permit his truck driver to do his radio installations. Some of the most slovenly jobs I have ever seen, have had more time and material cost, than it would take to pay an electrician to do the job right."

Here we might add that Mr. Whittaker has the power to enforce his stipulations with the aid of the police and judicial departments of the City of New York. Readers will observe, however, that Mr. Whittaker is not denouncing or clamoring for the blood of the Service Man. He merely calls attention to things as he finds them and

(Continued on page 504)

SHORT-CHECKERS and PREHEATERS

(PART I)

This is the first of a series of articles by Mr. Tillett describing the theory and construction of short checkers and preheaters

By JESSE TILLETT

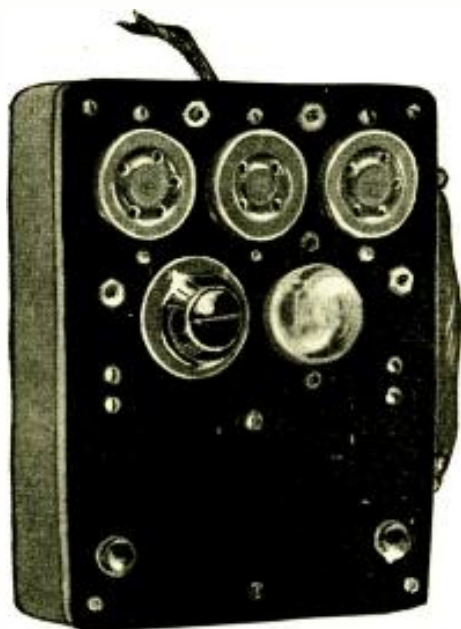

Fig. A
A simple short-checker and preheater.

IT is now standard practice with manufacturers of the better-grade tube-testing equipment to provide means for checking vacuum tubes for short circuits between elements as a preliminary to operating tests; and, in some designs, provision is also made for preheating the cathode type tubes.

It is the purpose of this paper to touch briefly on several practical means of making these tests and to describe and illustrate two working models embodying some of the principles discussed. It is not proposed to treat the subject in an altogether exhaustive manner. However, sufficient data will be given to enable any one to utilize such equipment as may be available in the design of a really practical test unit.

A few general considerations will not be amiss as a prelude to actual detailed discussion. To begin with, any short-testing device is essentially a form of continuity test, and any device suitable for this purpose can be adapted to the checking of vacuum tubes for shorts between elements.

Due however, to the need of a relatively simple and inexpensive arrangement, as well

as one of reasonably high sensitivity, the number of really practical arrangements is limited to comparatively few. The need of a reasonably high order of sensitivity comes about by reason of the occasional existence of partial shorts and leakage paths between elements (such as cathode to heater) and for this reason such devices as flashlight bulbs, electric lamps, or any device requiring comparatively high current for its operation are less effective than a more sensitive arrangement, such as a neon lamp, or a high resistance voltmeter (or its equivalent, a low range milliammeter with a series resistor appropriate to the meter range and test voltage used).

A further consideration is the desirability of testing certain tube types for shorts "hot," that is, with correct voltage applied to heater or filament terminals. This is particularly true of the cathode type tube and it is the writer's experience that in many cases shorts and leakage absolutely fail to show up with tube "cold." This point seems to have been entirely overlooked in some commercial designs.

A Neon Tube Short-Tester

Figure 1 shows an arrangement which is quite flexible, inasmuch as it can be adapted to the use of either neon lamps or six-volt dial lights as indicating devices. In the

event of using the neon lamp, the windings on the transformer (sec. Nos. 1, 2, 3, 4 & 5) should be 110 volts. If six-volt dial lights are used, the windings will of course be six volts. Note the fact that the ends of each of these windings are designated plus (+) and minus (-), respectively, which simply means they are connected series aiding with the indicating device placed in the connecting lead, as shown. It is quite essential to follow these exact connections. The same circuit could be used with 1.5-volt uni-cells in place of secondary windings 1, 2, 3, 4 & 5 (observing same polarity) with a 1.5-volt flashlight bulb in place of the neon lamps or six-volt dial lights. This, of course, in event A.C. is not available.

If using neon lamps for indicators and testing the tube "hot," it will be convenient to insert a 0.5- to 1-mf. condenser in series with each tube element as shown by dotted lines. The reason for this will be discussed later during the description of Figs. 4 and 5; also some data as to the best type of neon lamps to use will be given. Note the termination of filament leads, at the left of the drawing, with "XX." This practice is also followed in Fig. 2 and complete explanation will be found in Fig. 3 and its associated text. If desired, a chart to indicate the exact elements shorted can be worked out along similar lines to that shown in connection with Fig. 2.

Another Type of Tester

Figure 2 was lifted bodily from a booklet distributed by Weston Electrical Instrument Corporation entitled "Uses of Electrical Instruments for Radio Testing." The only changes being the before-mentioned filament circuit termination "XX" to the right of the diagram, and the addition of the dotted lines indicating possible insertion of a condenser of 0.5- to 1 mf. in value as mentioned in Fig. 1 and explained in detail in Figs. 5 and 6 and the accompanying text.

This condenser is only used in event it is desired to test the tube "hot" and then only in conjunction with a neon lamp and A.C. The "code," or chart, to indicate the exact elements shorted is given as an example of similar charts for other circuits also.

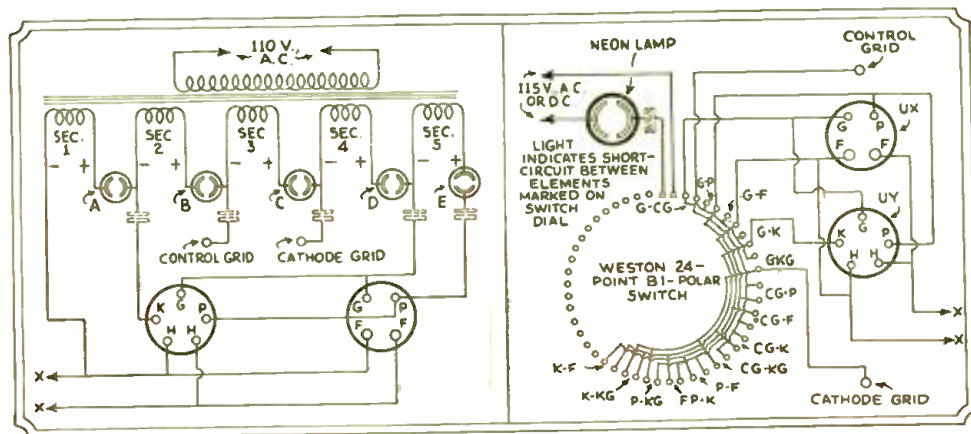

Fig. 1, left. *A simple short checker using five neon lamps and no switches.*

Fig. 2, right. *A short checker using one neon lamp and a rotary switch.*

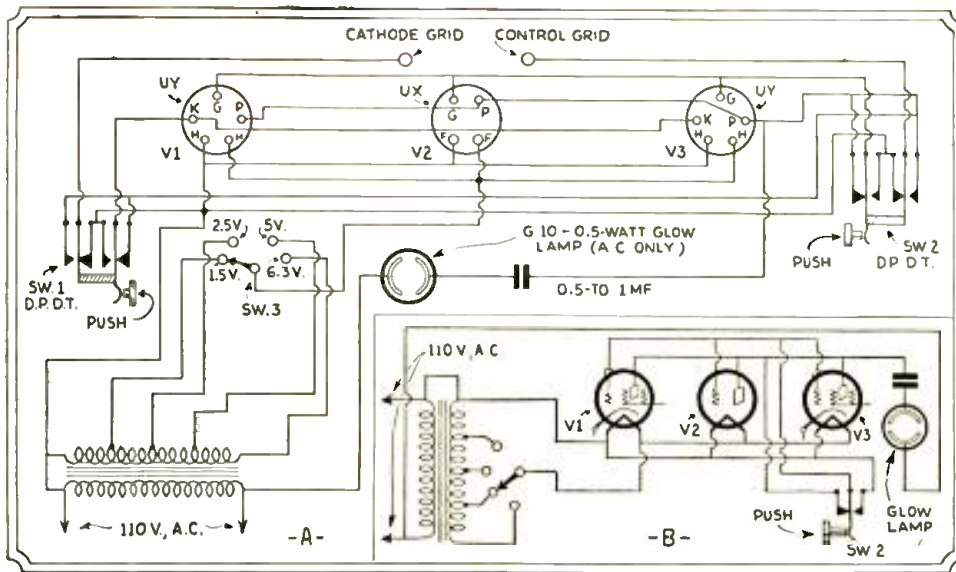

Fig. 4

The diagram of the short-checker and preheater illustrated in the photographs. Switches SW1 and SW2 operate the entire unit.

- G-CG—Grid-Control Grid
- G-P—Grid-Plate
- G-F—Grid-Filament
- G-K—Grid-Cathode
- G-KG—Grid-Cathode Grid
- CG-P—Control Grid-Plate
- K-KG—Cathode-Cathode Grid
- CG-F—Control Grid-Filament
- CG-K—Control Grid-Cathode
- CG-KG—Control Grid-Cathode Grid
- P-F—Plate-Filament
- FP-K—Plate-Cathode
- P-KG—Plate-Cathode Grid
- K-F—Cathode-Filament

Like Fig. 1, this circuit is also rather flexible, as it is possible to insert any other type of indicating device in place of the neon lamp, such as a dial light and dry cells, or an A.C. or D.C. voltmeter, etc., leaving out the series condenser in any case where other than a neon lamp and 110 volts A.C. are used. The neon lamp is simple, sensitive, rugged and inexpensive however, and is recommended.

In using any arrangement of this circuit other than the neon lamp and 110 volts A.C., it is recommended that the tube be checked with the filament or heater "cold," which limits the arrangement of the filament connections to that shown in either Figs. 3A or 3C.

Filament Connections

Figs. 3A, 3B and 3C show three practical types of filament connections, as illustrated in Figs. 1 and 2 and designated "XX" in each case. In many short-checking devices the practice is followed of putting a jumper across the filament as shown in 3A and this

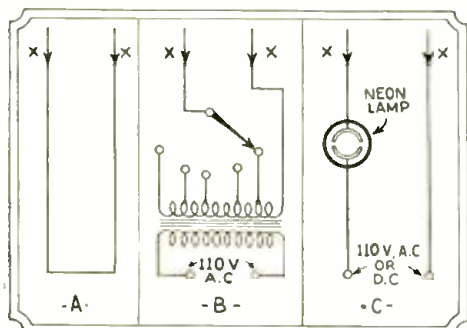

Fig. 3

The above three diagrams illustrate three methods of connecting the heaters of tubes to be tested.

is O.K. if the short-check is made with the filament "cold." 3B illustrates a preheating arrangement and when this is used, the tube is checked "hot." Fig. 3C shows a method of checking for filament continuity which can be used in conjunction with practically any short-checking circuit desired. However, in connection with Fig. 2 it would be simpler and just as satisfactory to return the filament leads to two terminals on the bi-polar switch next to those marked K-F, or to any of those that are blank or unused, and thereby use the same neon lamp used as short-indicator to indicate filament continuity. Of course, other variations of heater connections are possible and one of them is shown in the arrangement of Fig. 5.

A Short-Checker and Preheater

Fig. 4 shows the diagram of an interesting short-checker and preheater and Figs. A and B show the external and back of panel views. A satisfactory portable tube-tester was already available, but was not provided with means for preheating or checking for shorts and such a device of small size was desired to use with it. This is an age of "Midgets" so why not a midget short-checker and preheater?

This checker was accordingly built up on a 5 3/4 x 6 3/4 in. panel, and contained in a case 1 1/2 in. deep inside and has proven very satisfactory. Note that two D.P.D.T. push type switches serve to connect the various tube elements to the plate and to the filament of the tube under test in turn, and in various combinations. It is not usually important to know the exact elements between which a short exists as a short between any of the elements renders the tube useless.

The two switches mentioned are designated SW1 and SW2 in the diagram and they need only be pushed in turn (not together) to indicate every possible short in the tube. The reference points (or points of connection for the two sides of the test circuit) are the plate and filament respectively, and as stated the two push switches serve to connect the remaining elements in turn to the plate and to the filament circuit in proper combination to indicate all shorts.

Switch SW3 adjusts the filament voltage to any one of four values, and the range of voltages shown is sufficient as it is permissible to make such tests at slightly less than rated filament potential where the tube requires intermediate or higher values than those shown.

Some types of tubes burn so dimly as to make it difficult to determine whether they are lighted or not, and if a test of filament continuity on these types is considered essential, it is suggested that the circuit be altered to the extent shown in Fig. 4B. This simply involves adding a S.P.D.T. push or toggle type switch, which in the normal position completes the filament circuit through the filament switch and when thrown to the other position checks filament continuity on the same neon lamp used for the short-check.

The Neon Lamp

Note that the neon lamp is specified as G10-0.5-watt A.C. only. This is the standard designation used by General Electric Vapor Lamp Company of Hoboken, N. J. If the 0.5- to 1-mf. condenser is used in series with the neon lamp, it

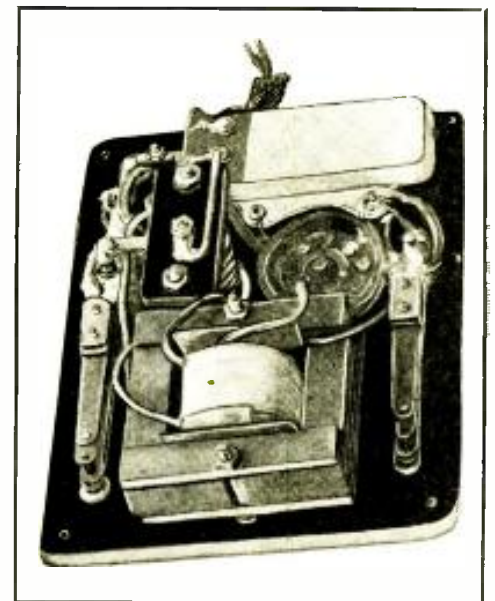

Fig. B

An under-view of the tester illustrated in Figs. 1 and 4. Observe the simplicity.

is possible to use other types of neon lamps. If the condenser is omitted, it is absolutely necessary to use the above type lamp in order to permit the tube being tested "hot," as otherwise the neon bulb will glow even though no short exists. This is due to the rectified plate current. However, using the type lamp specified, only one of the two electrodes in the lamp will glow as the electrodes are polarized, the glow taking place on the negative electrode, and as the normal rectified plate current is a pulsating D.C. current, partaking of some of the characteristics of both the A.C. supply and also D.C., the one electrode glows though the lamp is ostensibly responsive to A.C. only. This may not be objectionable to the user as no short exists unless both electrodes glow, which they will do when A.C. is impressed across the lamp due to a direct tube short.

(Continued on page 498)

Improving Operation

(PRIZE AWARD.)

Rewiring Battery Receivers for 2-Volt Tubes.

By B. T. STUBBS

IN the present "depression," the Service Man can pick up quite a few jobs re-wiring older model battery radios for the new low current "2-volt" (filament) tubes. In my case, I have rewired several models for owners whose storage battery developed a dead cell. With their machine using the 2-volt tubes, they are able to continue using the old battery, one cell at a time. When the old battery is no longer usable, they can use the new "air cell."

Figure 1 shows the Atwater Kent Models

"33" and "49," rewired for 2-volt tubes. Since with 90 volts "B" on the R.F. tube-plates, a negative bias of $4\frac{1}{2}$ volts is required, the secondaries of the first three R.F. transformers are disconnected from the filament, grounded through a .5-mf. condenser, and brought out to the "C" connection. There are only six wires in the cable, so the detector "B plus" is cut loose and connected to the R.F. and first audio plate-lead through a 10,000-ohm resistor and bypassed by a .5-mf. condenser. Then, the

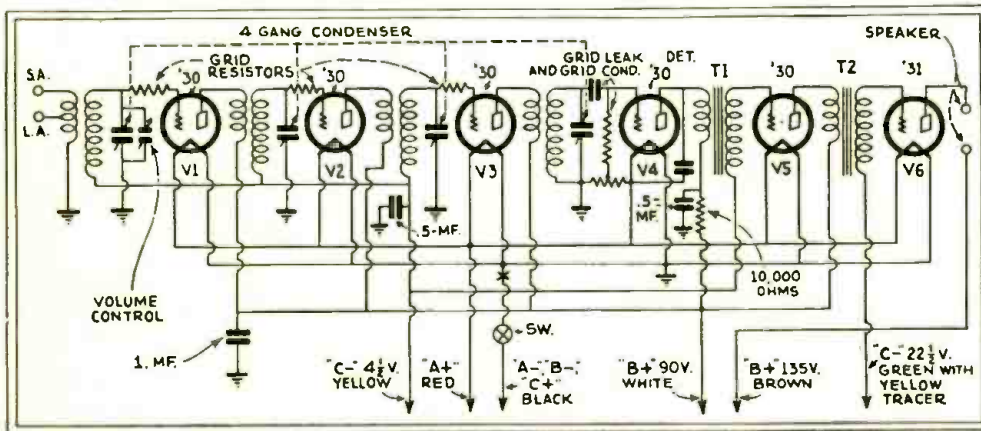

Fig. 1

Schematic diagram of the Atwater Kent Models "33" and "49" rewired for 2-volt tube operation. The "C" connections for the R.F. stages are grounded through a .5-mf. condenser.

\$10 FOR PRIZE SERVICE WRINKLE

Previous experience has indicated that many Service Men, during their daily work, have run across some very excellent Wrinkles, which would be of great interest to their fellow Service Men

As an incentive toward obtaining information of this type, RADIO-CRAFT will pay \$10.00 to the Service Man submitting the best all-around Radio Service Wrinkle each month. All checks are mailed upon publication.

The judges are the editors of RADIO-CRAFT, and their decisions are final. No unused manuscripts can be returned.

Follow these simple rules: Write, or preferably type, on one side of the sheet, giving a clear description of the best Radio Service Wrinkle you know of. Simple sketches in free-hand are satisfactory, as long as they explain the idea. You may send in as many Wrinkles as you please. Everyone is eligible for the prize except employees of RADIO-CRAFT and their families.

The contest closes the 15th of every month, by which time all the Wrinkles must be received for the next month.

Send all contributions to the Editor, Service Wrinkles, c-o RADIO-CRAFT, 98 Park Place, New York City.

wire in the cable that originally went to the detector (the yellow wire) is connected to the R.F. grid lead, and also to the first A.F. transformer grid return lead.

The best volume control found was the use of the "antenna adjusting condenser," as this has a knob on the front panel for manual adjustment. Of course, the filaments are cut loose from the two rheostats and connected direct. If an "air cell" type of "A" supply is to be used, a .7-ohm resistance is wired in at point marked X.

(Continued on page 494)

The Service Man's Forum

Where His Findings May Benefit Other Radio Technicians

ATWATER KENT SERVICE MANUALS

Editor, RADIO-CRAFT:
In the December issue of RADIO-CRAFT under the department "Service Man's Forum," appears a letter from a Mr. Jack Levine of Worcester, Mass. While we appreciate Mr. Levine's letter and his favorable comments on the Atwater Kent Service Manual, we wish to correct an impression which may be conveyed by his letter, in regard to our policy with reference to requests for the Manual from independent Service Men or service companies.

Service Manuals and Supplements are furnished direct from the factory to Atwater Kent distributors and dealers only. Requests which we receive from independent service companies or dealers not handling the Atwater Kent line, are always referred to the local Atwater Kent distributor. Our distributors carry a stock of Service Manuals, and if in their judgment additional service on Atwater Kent radio is needed in the locality from which the request comes, the distributor is at liberty to furnish a

Manual from his stock to the party making the request.

In the majority of cases, the local Atwater Kent dealer is able to perform any ordinary service which might be required, but there are occasionally exceptions, and we believe our local distributors, being thoroughly familiar with the conditions in their particular section of the country, are best able to make the decision in these matters.

To every letter we receive asking for the Manual, a prompt and courteous reply is sent, advising that the inquiry is being referred to the distributor for consideration.

The present Atwater Kent Service Manual consists of some 250 pages of printed matter and diagrams, covering sets from the early models of 1923, up to the present time. This is naturally an expensive publication, and it can be readily seen that it would be entirely impractical to furnish a copy in response to every one of the hundreds of requests received every month.

We are indeed anxious to have Atwater Kent service adequately handled in all lo-

calities, but it can readily be appreciated that it would not be advisable to place a publication of this nature in the hands of anyone without discrimination or consideration of ability or equipment. We feel that our local distributors are the logical people to determine, through their salesmen or dealers, the qualifications of any particular party asking for our Manual, and the requirements for additional service in the section from which the request comes.

We believe every fair-minded Service Man or company will appreciate the factory's point of view in this matter, and hope we have clarified this matter for all who might be interested.

ATWATER KENT MFG. CO.
L. A. CHARBONNIER, Service Manager.

(This department has received many letters from Service Men who have vainly attempted to obtain Atwater Kent Service Manuals, and about an equal number from men who have obtained them. Naturally, (Continued on page 494)

Operating Notes

The Analysis of Radio Receiver Symptoms

THE increasing popularity of radio-phonograph combinations has tended to broaden the scope of radio Service Men. The new field opened up by the advent of radio-phono combinations, and home "Talkie" outfits has made it necessary for every man to have a closer working knowledge of the principles of electricity and sound. A wide acquaintance with audio amplifiers is no longer amiss in the servicing of these new outfits.

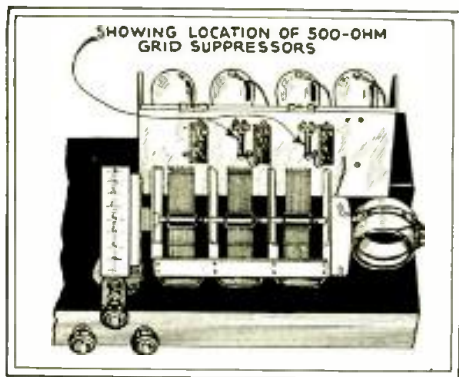

Fig. 2

Chassis layout of the Kolster K20 series showing the location of the grid suppressors.

Perhaps the very first point that should be well known is the fact that distortion in record reproduction is not always caused by defective audio amplifiers or dynamic reproducers. A most usual cause of this complaint is improper speed of the turntable. Most Service Men know that the speed of the turntable should be seventy-eight revolutions per minute. For speed adjustment, some outfits supply a stroboscope, but the most common method is to insert a two-inch strip of paper about one inch behind the record and turntable. With the record playing (pickup in position), the revolutions should be checked with a watch. When the speed is slow, more distortion results than when the rate is fast. However, for perfect reproduction, it is necessary that the phono speed be exact or as nearly so as possible.

In the centering of the armature of any magnetic pickup, it is extremely important that the magnet be kept in contact with the pole pieces or some other piece of iron or steel, should the magnet be removed for the necessary adjustment of the pickup. If the magnet is kept free for only a few moments, it is enough to impair and sometimes ruin the permeability and the effectiveness of the magnet as a pickup device. It is very simple to slide the magnet, keeping it engaged with the armature, for ease in adjusting the armature. A weak magnet will cause weak volume and distortion.

Most pickups employ a strip of soft

By BERTRAM M. FREED

rubber as a centering device for the armature and also as a damper for too rapid vibration of the armature. When the pickup is kept inactive for some length of time, the rubber strip will harden and throw the armature off to one side, no matter how many times, an adjustment is made. The remedy in this case, is replacement of the rubber damper. A good phonograph record to use in testing the low frequency response of a magnetic pickup is Victor record No. 21121, which has notes below 60 cycles recorded on it.

Radiola Model "48"

When employing a magnetic pickup with the Radiola "48" receiver and similar Victor models, it is best to use a pickup with an input transformer coupled to the proper terminals on the terminal strip of the receiver. It occasionally happens, however, that an annoying hum will result while a record is being reproduced. This condition can be eliminated by shunting a 5000-ohm resistor across the phono input-transformer secondary.

In the new RCA phono-radio combination, records other than Victor will not operate the automatic record-changing device, due to the difference in record-rejecting grooves. The Victor records have an eccentric groove, while others have concentric grooves. However, provision for these other records has already been made.

By the addition of a new part, which can be obtained from the distributor, any record can be made to operate the record-changing device. The trip-arm that oper-

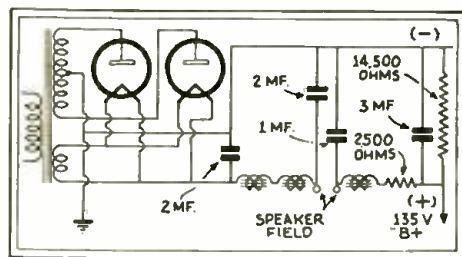

Fig. 1

Diagram of the Sonora model "444" power unit. An open bleeder will increase all voltages.

ates the stop switch should be removed from the mechanism. On this part will be found two holes already drilled to take the machine screws that hold the new part on the trip-arm. This part is slotted so that an adjustment can easily be made by sliding to the proper position. The two screws pass through the slot, through the drilled holes, and screw into the threaded strip that is supplied. The screws should not

be firmly tightened until the trip-arm has been fastened into place. The part should be set, so that the stop switch operates at the proper time. The machine screws should then be tightened.

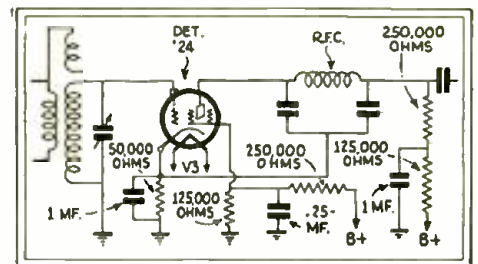

Fig. 3

Detail schematic of the Fada "43" detector unit. An open chassis-to-screen resistor caused distortion.

Brunswicks

The Brunswick Automatic phono-radio combination met with wide favor because of its low price and comparative simplicity. Certain precautions must be taken for proper installation and operation. The outfit is a heavy one but it is important that the cabinet stand on a level floor. Should the cabinet be tilted, the pickup arm will swing too far and start from a quarter to one-half inch from the beginning of the record. The loading compartment holds twenty records, and care should be taken that the records should not exceed that number and that each record be straight.

A warped record will jam the mechanism and perhaps seriously injure its operation. The common troubles on model "12" are but few and much need not be said of them. Sometimes, after the mechanism has been started, the records start rejecting continuously. This condition is a usual sign of a jammed solenoid plunger. To straighten this trouble, it will be necessary to loosen the two screws holding the solenoid to the iron frame and re-center the solenoid to free the action of the plunger. On some occasions, the motor will operate but the changing mechanism does not. Here, the solenoid should be tested. Usually, in the latter symptom, the solenoid will be found burnt out.

When the motor stops after a few revolutions after the starting button has been pressed, look to the cycle switch beneath the gears.

This switch will cause the above complaint by failing to make proper contact. However, a shorted cycle switch will cause the condition where operation of the off-on switch will fail to stop the motor. Should the motor stall or lose power while changing records, it would be wise to clean the

(Continued on page 501)

MAJESTIC MODEL 25—9-TUBE TWIN-DETECTOR

Superheterodyne Receiver Models Brentwood, Cheltenham, and Brucewood

Three new Majestic receiver models introduced by Grigsby-Grunow Co., Chicago, Ill., have features of special interest to Service Men. These models, the Brentwood (Jacobean Low-boy), Brucewood (grandfather clock pattern), and Cheltenham (highboy) incorporate "twin power detection," a type of rectification which was used in the Science Museum (London, Eng.) receiver, which was first described in America (at any length) in the April and May, 1931 issues of RADIO-CRAFT; this detector action was still further analyzed and discussed in the November, 1931 issue, page 298. The first reference to the Science Museum set (which incorporated the "paraphrasing" or twin power detection circuit) as a "perfect quality" receiver, was the original title, "A Perfect Quality Demonstration Receiver," in the April issue. It is recommended that Service Men refer to these articles in order to familiarize themselves with the theory and operation of such "two-detector-tube" circuits.

It is inadvisable to use any but Majestic tubes in these receivers, since tube shielding, which is part of the design of those tubes with code numbers terminating in the letter S, is essential to the correct operation of the several circuits.

Operating characteristics for the tube circuits of the Model 25 chassis are as follows: Filament potential, V1 to V8, 2.5 V.; V9, 5 V. Plate potential, V1, V2, V4, 260 V.; V3, 90 V.; V5, V6, 115 V.; V7, V8, 245 V.; V9, 400 V. Plate current, V1, 5 ma.; V2, 1 ma.; V3, 3.5 ma.; V4, 5.5 ma.; V5, V6, 14 ma.; V7, V8, 32 ma.; V9, 120 ma. (total). Filament-to-ground potential, V7, V8, 16.5 V. Cathode potential, V1, V4, 3.5 V.; V2, 8 V. Screen-grid potential, V1, V2, V4, 90 V.; V7, V8, 260 V. First filter condenser D.C., 385 V.; second condenser, 330 V. Field coil, 70 V. (Measurements to ground at 115 V. line potential, and volume control set at maximum.)

The Model 25 chassis employs the efficient superheterodyne circuit designed with a greater number of tuned stages to give the characteristics of uniform high sensitivity, single-channel selectivity (10 kc.), and nearly perfect A.F. response.

The circuit from antenna to speaker is arranged as follows: pre-selector, first-detector, oscillator, I.F. amplifier, second-detector (twin power detection), push-pull pentode power amplifier stage. Nine tubes are employed in the above mentioned circuits.

The Model 25 superheterodyne circuit differs from the regular superheterodyne circuit employed in the customary receivers, in that the design of the second-detector stage (through the use of twin-detectors) provides an almost perfect fidelity of signal output from the speaker.

The R.F. amplifier, first-detector, and I.F. amplifier are biased by the volume control, and a balance resistor of 160 ohms (contained within the control), which are in the cathode circuit of these tubes. The twin power detectors have in their grid circuit a 1/4-meg. resistor which returns to ground.

Control of volume is obtained in the Model 25 chassis by a 6,500-ohm control which varies the bias of the R.F. amplifier, first-detector, and I.F. amplifier stages.

In cases where low sensitivity is encountered, the first step taken to remedy the condition should be the checking of the R.F. types G-51 and G-51-S tubes. Tubes having a low amplification factor in any of these positions will seriously affect the sensitivity of the receiver. These procedures should always be taken prior to any attempts at remedy by realignment of the condenser gang.

The power supply system of the Model 25 chassis consists of a power transformer, filter unit, and dynamic speaker field. The filter unit contains two 8-mf. electrolytic designed dry electrolytic condensers, a liberally designed choke, and the speaker field in addition.

In checking the alignment of the Model 25 chassis, the I.F. transformers should not be aligned unless there is definite reason to believe that they are out of adjustment. The setting of these transformers at the factory is more or less permanent, and should not need further adjustment, except in rare cases. *In all alignment procedure an output meter must be used.*

The procedure in aligning the R.F. and oscillator tuning condensers is as follows: (1), tune

in a station in the vicinity of 1,500 kc., or put the output of a local oscillator (if available) into the receiver; (2), align the R.F. stage, and oscillator tuning condenser (the R.F. stage and oscillator aligning condensers are on the gang condenser).

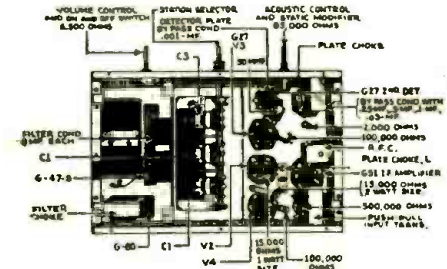

Under-view of the model 25 chassis. All parts are labeled for the convenience of Service Men.

To align the oscillator tracking condenser, the steps are as follows: (1), Tune in a local oscillator, set at about 600 kc.; (2), adjust both the tuning control and tracking condenser simultaneously to give maximum signal as noted on an output meter. This will be obtained by "rocking" the tuning control across the resonance point while adjusting the tracking condenser to give maximum output at the point of resonance. (This operation cannot be performed without a local oscillator and output meter.)

The alignment of the R.F. oscillator aligning condensers now should be checked in the vicinity of 1,500 kc.

The color code of the power transformer is as follows: Start and finish of primary winding, yellow; start and finish of anode, red; center-tap (anode), black; start and finish of No. 1 heater, black; start and finish of No. 2 heater, yellow; start and finish of 5-V. filament, black; center-tap of No. 1 heater, red.

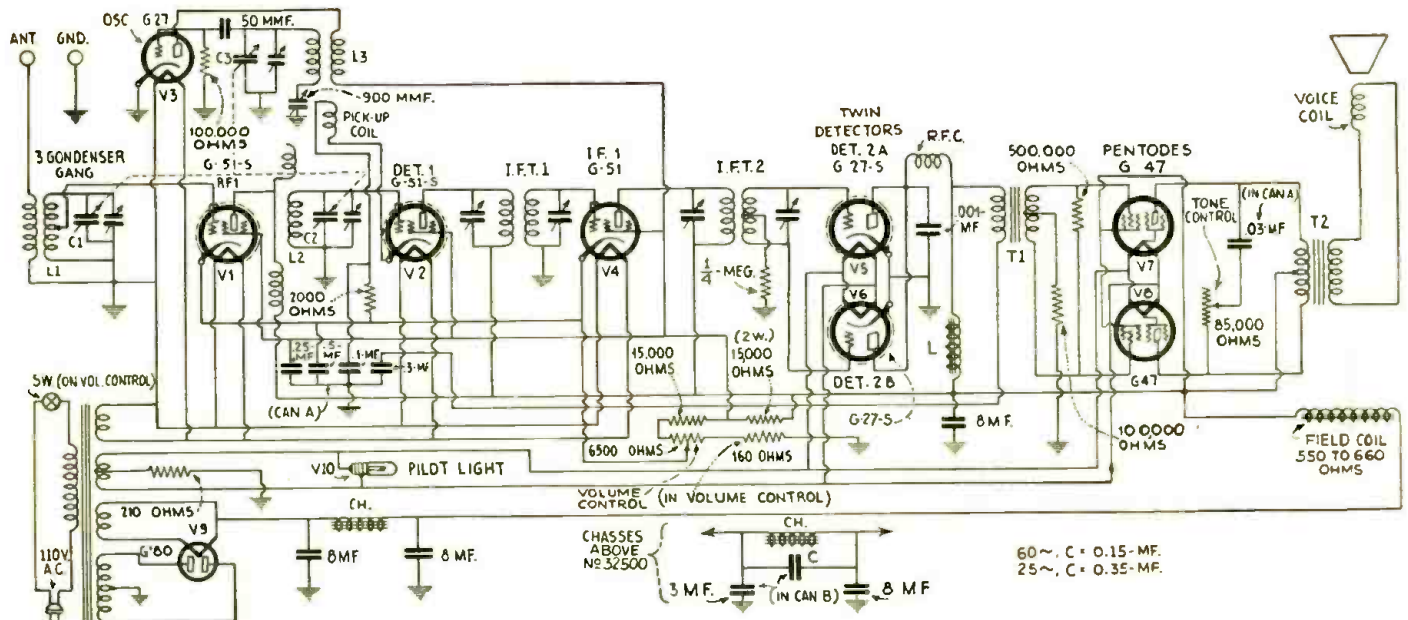

HOWARD MODEL 45 A. V. C. SUPERHETERODYNE WITH MODEL A. V. H. CHASSIS

The values of the components of this receiver chassis are as follows: Resistors R1, R3, R5, 1/2-watt; R2, R6, 500 ohms (1/2-watt); R4, 6,000 ohms (1/2-watt); R7, 30,000 ohms; R8, volume control, 1/2-meg.; R9, 1/2-meg.; R10, 3,000 ohms; R11, 2,000 ohms; R12, R13, 150,000 ohms (1/2-watt); R14, 2 megs.; R15-R16-R17-R18-R19, voltage divider, 9,900 ohms; R20, R21, 10 ohms (center-tapped); R22, 200 ohms.

Condensers C4, C5, C6, C7, I.F. trimmers; C8, C9, C10, C15, C16, 0.1-mf.; C11, .00025-mf.; C12, .001-mf.; C17, C18, 0.25-mf.; C19, C23, 0.5-mf.; C21, .05-mf.; C24, 1. mf.; C25, C26, 8 mf. (420 volts); C27, 4 mf. (420 volts).

In the interest of obtaining best results with the Automatic Volume Control receiver, it is important that the type '27 control tube V9 be a selected one, with a definite plate current cut-off when tested at 180 volts plate and 20 volts bias on the grid. This cut-off should be less than 5 microamperes. If there is no means available for checking the tube (in the form of a special tube tester), an immediate check for tube performance can be obtained in the set itself.

For instance, disconnect the antenna and short-circuit the aerial lead, leaving the control tube out of the socket, and note the swing of the tuning meter. Then insert the tube in the socket and if it is a good automatic volume control tube, there should be no change in the position of the pointer on the tuning meter. If there is a change in the position of the tuning meter pointer, namely, a swing toward the right, it is an indication that the A.V.C. tube does not have a definite plate cut-off; instead, it is drawing plate current and as a result the bias voltage on the regular R.F. and I.F. tubes has been raised, with the consequent cutting down in plate current.

The Model 45 speaker has a 350-ohm field, and as such it cannot be used with the Models 35 and 40 receivers.

The receiver housed in the regular cabinet is the "Model 45"; the chassis is the "Model AV11."

The automatic volume control functions in

holding the second-detector input voltage at a definite level, a system which is different from that in other receivers. A reduction of background noises, between stations, will be noted.

The only service met with to date on the Model "11" receiver has been in connection with the shorting out of the R.F. plate bypass condenser, the red lead of which may accidentally become wedged underneath the first I.F. coil can. The insulation does not cut through immediately but, after being in service for a number of days, the pressure on the insulation may be such as to gradually cut through it, shorting out the plate bypass condenser, and thus producing zero voltage on the plates of the R.F., first detector, and I.F. tubes.

The A.V.C. tube is so connected by means of a 2-megohm resistor, R14, that the grid is at absolute "B" potential. The cathode of the tube is connected to a point on the voltage divider which is at 24 volts positive, with respect to "B—" or the grid. There then exists between the cathode and the grid a potential difference of 24 volts with the grid negative by this amount. The plate of this tube connects to ground by means of two 150,000-ohm resistors, R12-R13. Since ground is connected to 124 volts, positive (with respect to "B—"), there exists between the cathode and the plate a potential difference of 100 volts. In order to bypass any R.F. energy which may appear on the plate, a non-inductive condenser C22 is connected from the plate of the A.V.C. tube to the cathode.

With the condition of no-signal there exists a bias of 24 volts and a plate potential of 100 volts. Under these conditions, there is no plate current flowing and the tube is said to be adjusted to cut-off. Since no plate current is flowing, there exists no voltage drop across the plate circuit resistors and, therefore, there is no bias voltage on the grids of the controlled tubes. The only bias on the R.F., first detector, and I.F. is caused by the respective voltage drops across their cathode resistors. These resistors are designed to give the most sensitive operating point.

In the case of a received signal, energy passes

through the receiver to the second-detector grid. Here the A.V.C. (automatic volume control) tube grid, and the second-detector grid, are in parallel. The signal voltage is fed to the grid of the A.V.C. tube through a small fixed condenser, C11.

It will be seen that during the positive half of the incoming cycle, the peak voltage of the signal swing subtracts from the original bias voltage; which means that the instantaneous bias on the tube is less than the original bias and the tube begins to draw current in its plate circuit. Since this current flows in the resistors in the plate circuit of the A.V.C. tube, there exists a voltage drop across these resistors; also, the flow of the electrons is from plate to ground so that the plate becomes negative with respect to ground. Now, since the original potential of the cathode of the R.F., first-detector, and I.F. tubes is positive with respect to ground, it follows that if the grids of the respective tubes are connected to a resistor in the plate circuit of the A.V.C. tube, that any potential existing across this resistor is added to the original bias and makes the grids more negative than the original bias by the amount of the voltage drop across the resistor in the A.V.C. tube plate.

It is at once apparent that the greater the signal voltage appearing at the grid of the A.V.C. tube, the more plate current will flow in the plate circuit; an increase in plate current means an increase in bias on the R.F., first-detector, and I.F. tubes; an increased bias on these tubes means less amplification and, therefore, less grid swing on the second-detector and A.V.C. tube. This cycle goes on until a constant voltage is obtained across the second-detector input, or, in other words, until a condition of equilibrium is reached.

Since R8 is located where the tone control is normally connected, it was necessary to relocate the tone control, C13-R9-C14. As less resistance is included between the two condensers, they become more effective in bypassing the higher audio frequencies; at the same time, they resonate the primary of T2 to a lower audio frequency.

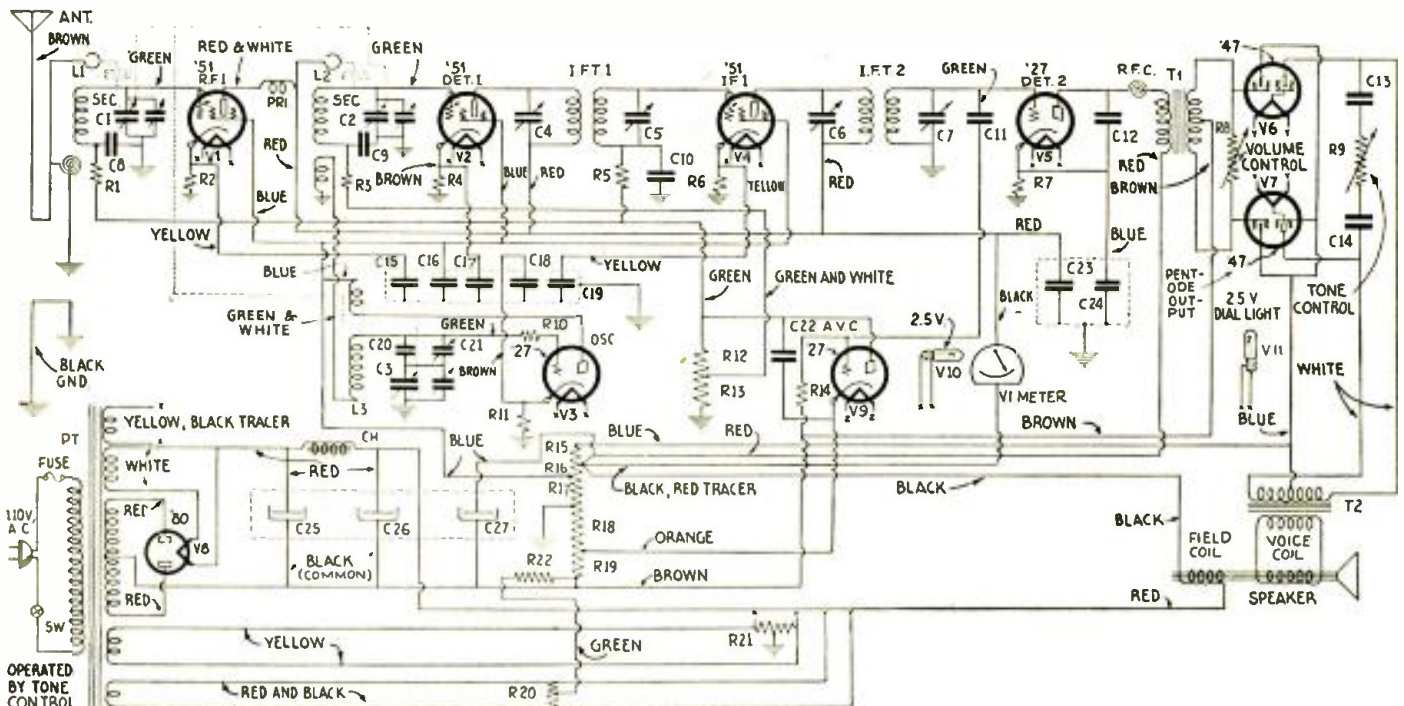

Resistor R15 is 450 ohms; R16, 3,000; R17, 3,750; R18, 2,250; R19, 450. Condensers C13-C14, 0.1-mf.; C20, .0009-mf.

A Self-Powered S-W Converter

*An attachment that enables the reception
of foreign stations*

By M. H. GERNSBACK

MOST of the short-wave converters that are now in use have several coils, at least one for the oscillator and one for the antenna stage. In order to change wavelength bands, it then becomes necessary to change at least two coils. In the converter to be described, all of the coils are wound on a single form and a single stage of I.F. is incorporated in an attempt to minimize any stray pickup.

The converter itself, illustrated in Figs. A and B, is a "three-tube" affair consisting of a modulator, an oscillator and an intermediate frequency amplifier. In addition, it contains a built-in power unit, eliminating the necessity of tapping the current supply of the broadcast receiver.

The short-wave range is covered by three plug-in coils. All the inductances used in the converter for any one range are wound on one form, eliminating the necessity for separate sets of plug-in coils for each band. There are six contacts on each of these forms, five of which are brought out to a regulation U-Y-type base, the sixth being in the form of a special wiping contact on the side of the coil form. The coil forms are tubular with an outside diameter of $1\frac{1}{2}$ ins. and a length of $2\frac{3}{4}$ ins.

Coil Construction

Coil No. 1 covers the band from 80 to 200 meters and is tight-wound with No. 24 enameled wire; 10 turns are used for the antenna coil, 34 turns for the modulator coil,

13 turns for the oscillator-plate coil and 20 turns for the oscillator-grid coil.

Coil No. 2 covers the band from 45 to 85 meters. It consists of four coils wound tight with No. 22 enameled wire; 9 turns for the antenna coil, 20 turns for the modulator coil, 11 turns for the oscillator-plate coil and 13 turns for the oscillator-grid coil.

Coil No. 3 covers the band from 15 to 49 meters. This form is wound with No. 22 enameled wire, but each turn is spaced from the adjacent turn by one thickness of wire. Eight turns are used for the antenna coil, 7 turns for the modulator coil, 8 turns for the oscillator-plate coil and 7 turns for the oscillator-grid coil.

The oscillator is coupled to the modulator through the screen-grid of the modulator tube as shown in Fig. 1.

This converter differs from the usual type in that it incorporates a sharply tuned stage of intermediate-frequency amplification following the modulator. This I.F. amplifier has a high gain and is not merely a coupling stage between the modulator and the broadcast receiver. The frequency of this intermediate stage is adjustable by means of the trimmer condenser C1 located at the back of the chassis, and may be varied between 900 and 1100 kilocycles. The circuit has a resonant peak in the vicinity of 1000 kc. and should be operated there for best results unless there is a strong broadcast signal near that frequency which might cause interference.

The main tuning control is the variable condenser C3 which is placed in the grid circuit of the oscillator tube. The modulator tuning condenser C2 is used as auxiliary control for fine tuning after the carrier has been tuned in on the main dial.

By means of a D.P.D.T. switch controlled from the front panel, the aerial may be connected directly to the broadcast receiver or it may be connected to the converter input. At the same time, the output of the converter is connected to the aerial connection of the broadcast receiver. It is not necessary to make any changes in the connections between the converter and the broadcast set once the initial installation has been made as the switch takes care of this.

The tubes required for operation are: one type '27 for the oscillator, two type '35 for the modulator and the intermediate frequency stage, and one type '80 for the power supply. The heaters of the tubes are operated on A.C. from the power transformer.

(Continued on page 502)



Fig. A

Front view of the S-W converter.

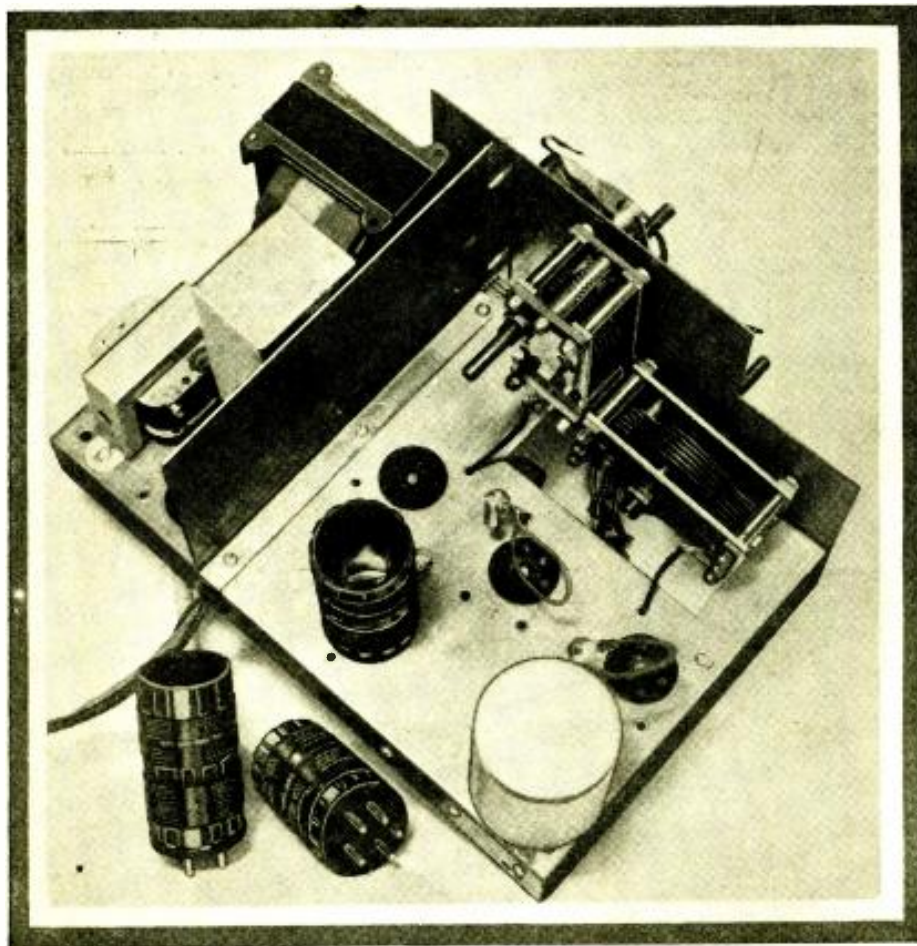

Fig. B

Chassis view of the self-powered S-W converter. All that need be done is to connect the converter to the receiver in order to receive short-wave stations.



THE FINEST BROADCAST RECEIVER THAT CAN BE HAD

In the 716-683
Ten-Tube Broadcast
Two-Unit Super
Pentodes in Push-Pull
Three-Vario-Mu Tubes
Double Tone-Control
Fractional Microvolt
Sensitivity
10 kc. Selectivity
11 1/4" Electro-Dynamic
Speaker

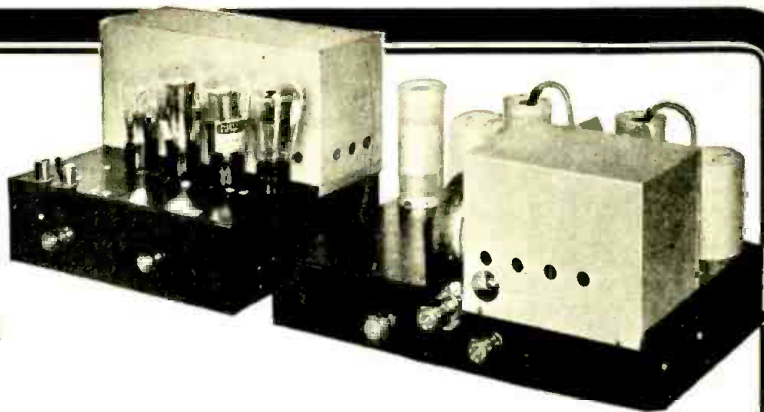

The 716 tuner as described above, completely factory wired, tested and RCA licensed. Size 16 1/2" long, 10 1/2" deep (exclusive of controls) 7 3/4" high. Shipping weight 25 lbs. Price \$69.50 LIST

The 683 amplifier is intended primarily for use with the 716 Tuner. Supplies required B, C, and heater currents. Designed to use with 855B Speaker (800 ohm field). See Page 7 of catalog for complete description. Factory wired and tested, RCA licensed. Price \$69.50 LIST

No All-Wave Receiver Will Beat the 726SW

In the 726SW

Nine-Tube Broadcast Super
Eleven-Tube Short-Wave
Super
No Plug-in Coils
Pentodes in Push-Pull
Three Vario-Mu Tubes
Sensitivity Between .45 and .7
Microvolts per Meter
Selectivity Absolute 10 kc.
11 1/4" Electro-Dynamic
Speaker

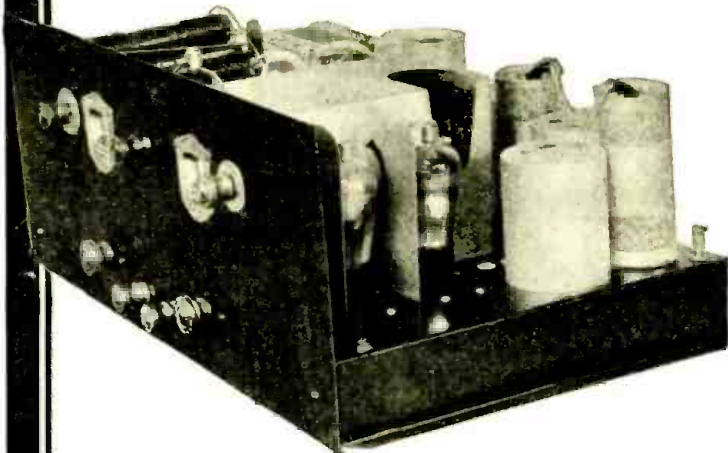

Tubes required: 2-'24's, 3-'27's, 3-'51's, 2-'47's, 1-'80.
 726SW All-Wave Superheterodyne, complete as described above, wired, tested, licensed, including S-M 855 11 1/4" electro-dynamic speaker unit. Size 20 1/2" long, 12" deep, 8 1/2" high. 110 volt A. C. Price \$139.50 LIST

SILVER-MARSHALL, Inc.
 6457 West 65th Street Chicago, U. S. A.

Canadian Division:
 SILVER-MARSHALL of CANADA, Ltd.
 75 Sherbourne Street, Toronto

Export Office: 41 Water Street, New York City, U. S. A.

SILVER-MARSHALL, Inc.
 6457 W. 65th Street, Chicago, U. S. A.

Please send me full technical details on the S-M 716-683 (enclosed you will find 2c).

Please send full technical details on the S-M 726SW (enclosed you will find 2c).

Please send me FREE your November General Parts Catalog.

Name

Address

RADIO-CRAFT KINKS

Practical hints from experimenters' private laboratories.

Prize Award, \$5.00

BUILDING A RESISTANCE CALCULATOR

By S. H. Burns

FEW experimenters are fortunate enough to have an ohmmeter or other instrument for the measurement of resistance. There is no end to the occasions that call for the use of some such device, even while carrying on the simplest of experiments.

With the current and the voltage known, the resistance can be calculated by applying the formula for resistance in Ohm's Law. A voltmeter and a milliammeter, when used in connection with a battery, will give these values. The disadvantage of this method is in having a voltage supply that is constant while the current that must flow through the resistance being measured, is drawn from it. Then too, a considerable variation in the voltage must be available to accommodate the measurement of greatly different resistance values with any degree of accuracy. For a low resistance measurement, it is not possible to use a high voltage; on the other hand, when dealing with higher values the voltage should be increased.

Where the work can be done quickly, batteries are satisfactory, but oftentimes the voltage required for accuracy may be as high as 100 volts. In these days of battery eliminators, it is somewhat of a problem to secure this battery voltage.

A Reliable Voltage Source

Various schemes were tried out while searching for something that would supply any reasonable voltage for as long a time as was necessary to complete the work at hand. It was decided that 100 volts would be sufficient for all requirements. The A.C. lighting circuit seemed to offer an unflinching source of energy. Now to convert this into the direct current required. After discarding several ideas as altogether too complicated, the scheme illustrated in Fig. 1 was adopted.

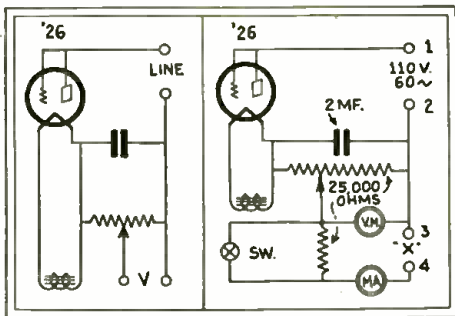

Fig. 1, left

Theoretical circuit of the resistance calculator.

Fig. 2, right

Final circuit diagram of the calculator.

The only things needed are a tube for rectifying and a variable resistance to regulate the voltage output supply. Several tubes were tried and a '26 was selected since the rectified voltage was plenty high enough and the current output sufficient. Then also, most experimenters will have several of these tubes not in use since they have been replaced by other types.

\$5 FOR A PRACTICAL RADIO KINK

As an incentive toward obtaining radio hints and experimental short-cuts, RADIO-CRAFT will pay \$5.00 for the best one submitted each month. Checks will be mailed upon publication of the article.

The judges are the editors of RADIO-CRAFT and their decisions are final. No unused manuscripts are returned.

Follow these simple rules: Write, or preferably type, on one side of the sheet, giving a clear description of the best radio "kink" you know of. Simple sketches in free-hand are satisfactory, as long as they explain the idea. You can send in as many kinks as you wish. Everyone is eligible for the prize except employees of RADIO-CRAFT and their families.

This contest closes on the 15th of every month, by which time all the Kinks must be received for the next month.

Send all contributions to Editor, Kinks Department, c-o RADIO-CRAFT, 98 Park Place, New York City.

The 110-volt line has one side tied to the grid and plate terminals of the tube while the other side of the line is not connected to the rectifying tube directly. A variable resistance of 25,000 ohms is in series with the tube filament and the other side of the line. The 2-mf. condenser shown across this resistance levels out the rectified voltage just as in any rectifying circuit. It can be of the low-voltage bypass type since the voltage is not great.

The filament of a '26 operates on 1.5 volts and consumes 1.05 amps. An idle filament transformer having such a winding can be used for this; or, if one is not handy and the device is to be made more or less permanent, a heater transformer can be quickly made. For the core, remove the laminations from a burned-out audio transformer. That portion of the core inside the coil is in most cases about 1/2-in. square.

If the dismantled transformer had a bobbin in which its coil was wound, remove the wire and use the bobbin for the new coil. Otherwise, a form can be easily made of cardboard. The total current is low, there-

fore a primary wound with No. 32 B&S wire will carry it. Using this wire with enamel insulation, or better still, enamel and silk, wind 1800 turns on the coil and insulate it with tape. As the wire is quite thin, flexible leads had best be soldered to the start and finish of this primary. The 1.5-volt winding consists of 24 turns of No. 20 B&S enameled wire. Cover the coil with tape to protect the wire. The laminations should now be put back in place in the new coil. To eliminate any tendency to hum, dip the transformer into a pot of melted wax; this when cool will hold everything firmly.

The Variable Voltage Feature

In Fig. 2, the parts are shown connected diagrammatically. It is the connection from the movable arm on the 25,000-ohm resistor that gives the voltage and current used for our purpose. With the arm at the end nearest the filament connection, the voltage obtained will be 100 volts when the maximum of 10 ma. is being used. The drain through the resistance will be about 4 ma., making the total less than 15 ma. at maximum.

The meter connections are shown in this figure also. The voltmeter should have a 0-100-volt scale and preferably marked in 10-volt divisions. The 2500-ohm resistance in series with the milliammeter is only used when measuring low resistance, and can be cut in or out of the circuit at will, with the single pole switch shown.

The Resistance Curve

To eliminate the necessity of working out each resistance problem, the curve given in Fig. 3 is used. Along the lower edge appear the current values in milliamperes. The resistance in ohms is at the left, vertically. This curve gives the resistance value directly when the voltage used in measuring is 10.

(Continued on page 503)

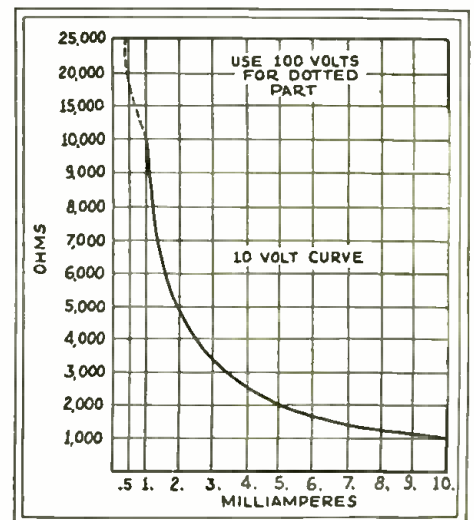

Fig. 3

The 10-volt calibration curve. The dotted portion is for an applied voltage of 100.

Over 25,000 Men have been trained under my supervision for the Better Jobs in RADIO



PROOF

R. L. DUNCAN, *President*
Radio Training Schools



As a graduate and a student under your supervision, I have only the highest praise and satisfaction to offer. Any man of ordinary intelligence wanting to learn Radio could not help but master it by your method of training.

GEORGE A. KRESS,
2997 Montclair Ave., Detroit, Michigan



I am a Projectionist in charge at the Andelus theatre, recently completed. You may quote me at any time or place; refer to me, if you wish, anyone who may be interested in this vast virgin field of all that pertains to Radio and its many allied industries, and I shall be delighted to champion honestly without any reservation, your courses.

A. H. STRENGE,
3005 Woodburn Ave., Cincinnati, Ohio.



To study Radio under R. L. Duncan is to learn it properly and in a way that is pleasant and fascinating. Once again thank you for your kind assistance and helpfulness.

E. E. PRICE,
101 Cochrane St., W.,
Moose Jaw, Sask., Canada.



Although it has not yet been a year since I enrolled for a course under your excellent supervision, I have opened a Radio Service Shop that is effective, successful and profitable. People come for my services from everywhere.

RUSSELL PEARCE,
936-18th Street, Des Moines, Iowa.

IN hundreds of Broadcasting Stations . . . in Radio Manufacturing Plants throughout the country . . . in Radio Laboratories . . . in Wholesale and Retail Radio Stores . . . in Radio Servicing . . . in Sound Motion Picture activities . . . on hundreds of ships that sail the Seven Seas . . . and even in the latest Television developments—you will find ambitious men who have been trained under my direct supervision.

I have devoted the last twelve years exclusively to the training of men for all branches of Radio. Employers in the Radio field recognize my methods of qualifying men and young men. I have geared my training to the rapid growth and development of the Radio industry. My courses, text books, methods and equipment are based on years of practical experience.

And now, with the organization of my own independent Radio Training Schools, Inc., I am better prepared to help you than ever before, in training for the opportunities which the future of the ever-growing Radio industry will have to offer.

You too can train for Future Success in Radio

The next few years will offer more prospects than ever before. The past several months offer positive proof that the trained man has the best chance. You still can get that training which will qualify you to gain a foothold in Radio. Study at home, in spare time, at minimum expense. Earn while you learn. Capitalize your idle and spare time and reap the benefits of a trained man in a progressive industry—Radio.

Make your Idle and Spare Time Profitable

My courses include everything needed for thorough training. There are no "extras" or "specials" to cost you extra money. The lessons, text books, methods, correcting, grading and returning of examinations, all the extra help and personal consultation you need . . . everything is provided until you complete your training.

RADIO TRAINING SCHOOLS, INC.
326 Broadway New York City

And in addition you are assured *practical* as well as theoretical training.

Pick Your Branch of Radio

I am offering four distinct Radio training courses:

1. Talking Motion Pictures—Sound
2. Radio and Broadcast Operating
3. Practical Radio Engineering
4. Radio Service and Mechanics

Each course is complete. Each starts out with simple principles well within your grasp. Each is right up to date, including latest developments such as Television. Each prepares you for a good paying position. Each leads to a Certificate of Graduation.

Advanced Training for Radio Men

My Practical Radio Engineering Course is an advanced course intended for Radio men who want to go still higher. It provides that necessary engineering background which, combined with practical experience, qualifies the man for the topmost job.

Ask for Facts—Write Now!

Let me sit down with you for an hour or two at your convenience. Let's go over the possibilities in Radio. This we can best do by means of the book I have just prepared. It covers the many branches of Radio and the kind of training required. Be sure to get your copy . . . it is free.



Mr. R. L. DUNCAN, *President* RC-2
Radio Training Schools, Inc.
326 Broadway, New York City

Without incurring the slightest obligation on my part, please send me a copy of your latest book, "Facts About Radio."

Name

Address

City..... State.....

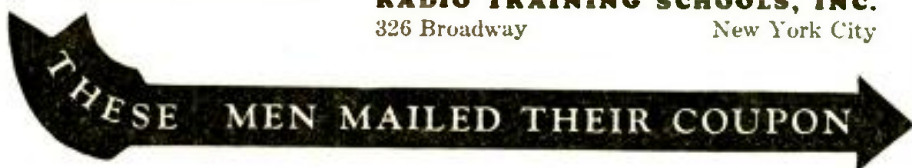

ELECTRICAL ENGINEERING BOOKS SENT FREE

New Edition Containing 100 Pages

A-C RADIO!

We're glad to send a set to your home to examine and use as your own for 10 days—to show you that here is the most up-to-date and complete work on Electricity ever published. Written by CROCKETT of Columbia U.—MILLIKAN of Calif. "Tech."—HARRISON of General Electric and 26 other noted Electrical Engineers. Starts off with elementary Electricity in simple, non-technical language for the beginner and includes every Engineering branch for use of experts on the job.

8 FLEXIBLE MAROON VOLUMES
4300 pages, 3200 illustrations, deluxe gold stamped binding. Index in each book, general Index in Vol. 8. Covers every subject in Electricity—Light, Power, Transmission, Generators, Motors, Switchboards, Radio, Telephone, House Wiring, Railways, etc.

Complete Electrical Reading Course

Electricity, the biggest industry in the world, continues to grow the most rapidly. And it offers better jobs, bigger salaries and a brighter future than any other field. Every dollar, every hour invested in learning Electricity will come back to you a thousand-fold. Learn in spare time with these books at one-fifth the cost of trade courses. Outline for organized study, quiz-questions and a year's free consulting membership in the American Technical Society included without extra cost, if you mail coupon immediately.

LOOK IT UP!
Thousands of these sets are used as REFERENCE books by men employed in electrical, building construction and allied lines. The JIFFY INDEX puts the answers to 20,000 questions right at your finger tips.

AMERICAN TECHNICAL SOCIETY
Dept. E-226
Drexel Ave. & 58th St., Chicago



AMERICAN TECHNICAL SOCIETY
Dept. E-226 Drexel Ave. & 58th St., Chicago
Please send for 10 days' free trial 8-volume set of Electrical Engineering just off the press, subject to return if I wish to. I will pay the few cents' express charges on receipt of books; you pay express if returned. If I decide to keep them, I will pay \$2.00 after 10 days' trial, then \$3.00 a month until \$31.50, special advertising price, is paid, after which books become my property. Year's Consulting Membership to be included free.

Name
Address
Employed by
Employer's Address

SERVICEMEN!

Resistor Replacement Manual
FREE with purchase of 10 Lynch Metallized Resistors, or \$1 cash
MORE THAN 200 CIRCUITS

Give the value and role of each resistor and its position in the circuit, of nearly every popular make of radio. **SAVES TIME** and experimenting.

LYNCH Resistors
Write for Manual today.
LYNCH MFG. CO., Inc., 1775RC BROADWAY, N. Y.

Metallized

1, 2, and 3 Watts

MICROPHONES
Indispensable for many uses is the combination Midget Microphone and Earphone Model Illustrated No. 306 \$7.50, with earphone.
SPECIAL NET PRICE LIST
No. 300 Single Button Carbon Type Stretched Diaphragm \$9.00
No. 301 Two-Button Carbon Type Stretched Diaphragm ... \$15.00
No. 302 Two-Button Heavy Duty Type 30.00
No. 303 Two-Button Concert Model 45.00
Also complete accessories for public address work
Write for Catalog
MILES REPRODUCER CO.
26 E. 22nd St., N. Y. C.



Radio-Craft's Information Bureau

BALANCING THE VICTOR "MICRO-SYNCHRONOUS" RECEIVER

(148) Mr. Arthur Parrish, Basking Ridge, N. J.

(Q.1) Please explain in detail the manner in which the Victor "Micro-Synchronous" receiver is to be balanced. The aligning procedure in connection with this radio set model differs greatly from that followed in any other radio set, and therefore it is considered best that accurate instructions be available before any attempt is made to align a chassis at the five frequencies specified by the manufacturers.

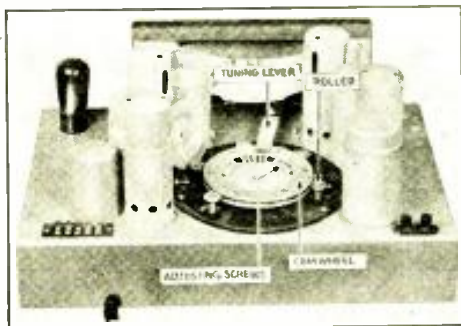

Fig. Q.148A

Top-of-chassis view of Victor "Micro-Synchronous" receiver.

(A.1) The decision to "hold-off" re-aligning the "Micro-Synchronous" receiver was an exceedingly wise one; in fact, this policy should be followed in connection with the adjustments of any receiver about which there may be any considerable doubt.

Incidentally, it may be mentioned that the same tuning mechanism has been used in a number of past models of Victor radio sets, and is retained in the new numbers, the R-35, R-39, and RE-57, the chassis of which are represented in Figs. Q.148A and Q.148B. The schematic circuit is shown in RADIO-CRAFT Data Sheet No. 33, which appeared in the January, 1931 issue.

Looking at the top of the chassis, there is seen a round wheel to which is attached a long metal arm, ending in the tuning knob. In the center of this unit, called the cam wheel, is a small metal plate, which, when removed, reveals five groups of five screws each. Spaced at equal intervals around the cam wheel are five rollers, each of which touches the flexible track around the outer edge of the cam wheel.

Looking at the bottom of the chassis, after the condenser shields have been removed, five tuning condensers are seen. Each one is pivoted or supported at one point only. The side of the condenser opposite the pivot point is free to move within certain limits, although it is being held in position by one of the round springs. It is also noted that the roller on top of the chassis is attached to this movable side of the tuning condenser.

The driving action, which produces the scissors-like motion in the condensers when the tuning lever is operated, is not from the rollers, but is through the micarta connector links which are attached to the five metal rods fastened to the underside of the cam wheel.

Thus, it is seen that the condenser moves in two ways,—a comparatively large amount of the action of turning the cam wheel, and a very small amount on one set of plates due to the roller on top of the chassis following the irregular track around the outer edge of the cam wheel. This last-mentioned movement is the compensating motion which is the "secret" of these receiver models.

Note that the station selector is set at 550 kc., the first screw of each group of five is exactly opposite a roller; at 710 kc., the second screw of

each group is opposite a roller; additional points, all of which are known as the aligning frequencies, are found where the other screws are opposite the rollers.

By connecting a voltmeter in place of the loud-speaker as an output indicator, by setting the tuning lever at 550 kc. while a local signal generator (service oscillator) is being operated, it is possible to adjust the first screw of each group of five to a certain point where the largest reading, corresponding to the loudest signal, is obtained on the meter; thus indicating that each of the five tuning-condenser circuits are in alignment.

This is due to the fact that the end of the screw caused the roller to move in or out slightly, depending upon the direction the screw was turned. This movement of the roller, of course, produced a slight compensating movement in the condenser. Thus, at 550 kc., the set is performing at its highest efficiency because it is electrically in perfect balance. The screws hold their adjustment because they are locked in place with a rubber gasket.

The tuning lever is next set at 710 kc., at which point the second screw is opposite each roller, and adjustments are again made as at 550 kc. This procedure is followed also at the remaining frequencies, 1,000 kc., 1,300, and 1,500, each time adjusting the proper screw opposite each of the five rollers.

The ends of the screws thus determine the track around the outer edge of the cam wheel, which in turn determines the inward and outward movement of the rollers, for each successive position of the dial.

Because of the flexibility of the track around the outer edge of the cam wheel, there is a gradual change in the roller movement and not a definite jump at the point where the rollers are directly opposite the screws. Thus, the condensers also align at the various positions between the five previously mentioned points of alignment.

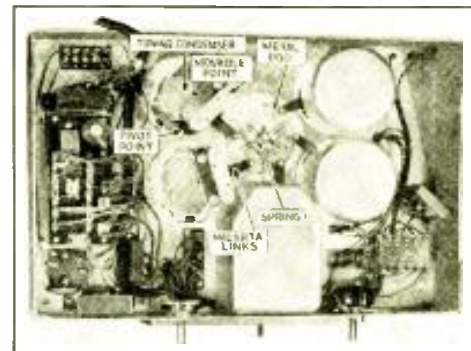

Fig. Q.148B

Under-chassis view of Victor "Micro-Synchronous" receiver. Observe tuning and adjusting mechanism.

FRANCE'S "NOBLE EXPERIMENT"

CREDIT to World-Radio the interesting statement that although there is a law in existence in France compelling all radio set owners to "declare" them, and pay a small tax, it is one more honored in the breach than in the observance. No one bothers about enforcing the law, well-knowing that the position will be changed when the Broadcasting Bill is passed.

"Bootleggery" seems to be international!

HOLLIS BAIRD ON "TELEVISION SETS"

"WITH the present high state of refinement of tone in the modern broadcast radio receiver, anyone who delays purchasing these remarkable instruments at their present extremely low prices with the idea 'they will wait' until television brings them a receiver for both sight and sound are neglecting a great opportunity. We, for one, haven't the slightest intention of putting out such a combination set for many years.

"The great television market comprises those people who have been visionary enough to invest probably \$150 each in first class radio sets and enjoy them. These will be ideal only for receiving the *sound* programs from the studios that send out pictures; now we want to build *television*, not sound, radio sets.

"Television and sound radio are two distinct subjects, two arts, and the only thing related about them in the future will be that the programs will emanate from the same studio. From that point the connection ceases. The sound part of the program will go out over the present broadcast waves and be received on the present type of broadcast set. The picture part of the program will leave the studios by way of entirely different apparatus, go out over a wavelength entirely separate from the broadcast band, demanding a completely different receiver for its reception. Thus in the home the sight and sound entertainment will be two distinct features.

"Since this is so, why should we want to build up *sales resistance* by incorporating a broadcast set in the same cabinet with our television set, two distinct sets merely housed together, and then have to charge the extremely high price this combination would demand, at the same time, asking our prospective customers to get rid of their existing and highly satisfactory broadcast sets at a loss? The idea is too ridiculous for any thinking person to seriously consider.

"Then again, we know that the broadcast receivers, having changed so little during the past year, merely refinements, have become a stabilized product. But television, as good as we may be able to make it this year, will have to have a ten-year period of development even as has sound broadcasting and at the end of that time the television receivers will probably be quite different from the very best ones we will sell during the next three years.

"Thus to sell a television receiver in a cabinet with a broadcast set and then find television changing after a few years, yet the broadcast set as good as ever, would certainly not be wise and would necessitate the junking of a perfectly good broadcast receiver because it happened to be housed in the same cabinet with the outgrown television set.

"No, indeed. We intend to make television a very separate thing from broadcast reception, a separate machine. As a separate receiver it can be changed as the passing years improve television. The sound will be coming in over the present highly developed broadcast sets during that time."

A THOUSAND RANGES from this HANDY KIT!

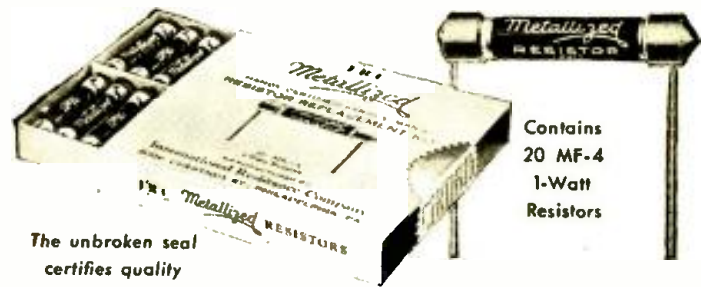

The unbroken seal certifies quality

Contains
20 MF-4
1-Watt
Resistors

GOOD news for the Servicemen who have been asking us for a compact "resistor kit"! Good news for every repair man who wants to speed up his work.

This new Certified Kit contains 20 Metallized Units of the most-used sizes—500 ohms to 3 meg-ohms. It is

FACTORY-SEALED, FACTORY-TESTED, and FACTORY-GUARANTEED

It gives any value you want. A thousand ranges—two thou-

sand—or more are possible from this little kit. Free information with every kit tells you how.

Ask your jobber—and be sure the seal is unbroken when you receive the kit.

Metallized Resistors, at their new low prices, offer the greatest value in the resistor field today. The purchase of the Certified Kit entitles you to our I. R. C. Resistor Replacement Guide free—and in addition, our R. M. A. standard Color Code Chart. See your jobber today.

INTERNATIONAL RESISTANCE COMPANY
PHILADELPHIA TORONTO

I R C

I. R. C. Resistor Replacement Guide.
PRICE \$1. Free with purchase of 10
Metallized Resistors.



Metallized
RESISTORS

EVERY SERVICEMAN NEEDS THE I. R. C. GUIDE. MAIL THIS COUPON

INTERNATIONAL RESISTANCE CO., 2006 Chestnut St., Philadelphia.

C-2

Gentlemen:

I enclose \$1.00, for which please send I. R. C. Resistor Replacement Guide.

Please send complete data on Metallized Resistors. I wish to purchase assortment of 10, entitling me to Resistor Guide Free.

Name.....

Address.....

City..... State.....

Make Depression Pay!

Take advantage of the present demand for repair of old receivers! Build strongly for the future, and increase your business by giving GUARANTEED REPAIRS. You can do this safely by using Radio's Finest Parts—

POLYMET PRODUCTS

Standard of the Industry

The new 1932 Polymet Catalog lists the widest line of replacement parts offered by any manufacturer. You need it. Send the coupon below, and we will include a remarkable low-price offer on the most useful Condenser Repair Kit ever assembled.



POLYMET MFG. CORP.
834 East 134th St.
New York City.

Send me your sensationally low-priced introductory offer on the Polymet Condenser Repair Kit. Also include the new 1932 Polymet Radio Parts Catalog, without charge.

Name _____
Address _____
City _____
State _____

Mark Proper Square

- JOBBER DEALER
 SERVICE MAN CUSTOM SET BUILDER



UNIVERSAL 2-BUTTON HANDI-MIKE \$15.00 List

Maximum volume, minimum hiss, scientifically damped. Truly natural in tone and the most rugged microphone yet devised. No delicate parts to be damaged if dropped, jarred or roughly handled. For announcing, transmitting or home recording. Our Engineering Department is at your service. New catalog covers twelve models from \$5.00 up.

UNIVERSAL MICROPHONE CO., LTD.
1163 HYDE PARK BLVD.
Inglewood, Calif. U.S.A.

NEW TUBES FOR OLD

THE R. F. VARIABLE-MU PENTODE

(Continued from page 458)

the plate current entirely, while the '39 retains its smooth variation of plate current.

True, the mutual conductance is lower for large biases than for small ones, but it is this feature that gives the tube its variable-mu characteristic. This may be verified by reference to Fig. 2. Starting with a zero bias and increasing negatively, the mutual conductance decreases in almost a straight line until a negative bias of 10 volts is reached, at which point the curve bends (concave upwards) gradually decreasing in a smooth line, until at 40 volts the mutual conductance is zero.

The Variable-Mu Action

Let us see exactly what goes on in the tube when a strong signal is being received. Assume the tube is operating at its normal control-grid negative bias of three volts, and a strong signal is impressed on its grid. To reduce the volume, the bias must be increased, and in doing so, the mutual conductance is lowered, causing a reduction in output. The stronger the signal, the greater the bias must become, and if a uniform decrease in signal strength is to result, then the mutual conductance must vary uniformly. What would happen to the signal if a '36 were used instead of a '39 may easily be predicted by reference to Fig. 2.

Fig. 3 shows the variation of mu and the plate impedance of the '39 with grid bias; these curves being accompanied by similar ones for the '36. Reference to this set of characteristics will indicate that the mu of the tube decreases for the larger values of grid biases, resulting in a reduction in the over-all amplification obtainable. This is in accordance with our previous conclusions arrived at in the study of the mutual conductance curves.

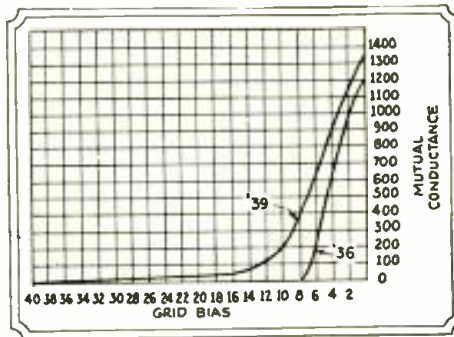

Fig. 2

The curves above show the relation between the grid bias and mutual conductance of the '39 and '36.

For normal operation, the negative bias on the tube should vary between 3 and 45 volts. This range should be sufficient for the greatest signals usually encountered in practice. With such large control-grid variations, it is possible that the plate and screen voltages may vary considerably, changing the operating characteristics of

the tube. For good stability, however, the screen-grid potential should not exceed 90 volts when the plate-current flow is maximum, and should not exceed 135 volts for minimum plate-current. This variation in plate and screen-grid voltages will not impair the operation of the receiver in which these tubes are employed.

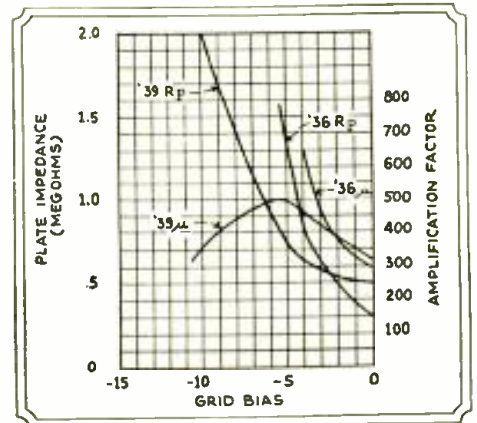

Fig. 3

The amplification factor and A.C. plate resistance for different grid biases of the '39 and '36.

The Cathode

The new five-electrode tube uses a coated cathode of the semi-quick heater type designed for D.C. operation only. Because of the cathode design, the heater voltage may vary between 5.5 and 7.5 volts during operation (which is not an uncommon range of battery voltage in an automobile battery) without affecting in any way the normal life and serviceability of this tube.

The socket of this tube is of the standard UY type and may be mounted for either a vertical or a horizontal position of the tube. Standard connections to the terminals are made, the control-grid being connected to the cap on the top of the tube.

Stable operation is secured if the recommendations of complete shielding of all the elements of a particular stage are carried out. If this is not done, the maximum possible amplification will not be obtained. Radio frequency filters in all leads entering the stage shields are desired, as only in this manner can coupling between other stages be reduced. Bypassing of the screen-grid to ground is recommended as a means of securing isolation of stages.

The screen-grid voltages may be obtained from a tap on the "B" supply battery for automotive receivers, or from a bleeder circuit across the power source in the case of D.C. line-operated receivers. A resistor in series with the screen-grid and the high voltage point may also be used to secure the desired voltage, providing the cathode resistor method of obtaining bias is employed.

The '39 as a Detector

The '39 may not ordinarily be used as a detector working directly into an audio amplifier. However, it does have a very useful (Continued on page 488)

NEW TUBES FOR OLD TRIPLE-TWIN

(Continued from page 459)

site to normal operation where the output voltage is 180 degrees out of phase with the signal.

The simplified equivalent circuit given in Fig. 2 is useful in analyzing the triple-twin. In order to maintain a voltage across Z , which represents the effective load-impedance of the first section, independent of the internal grid resistance R_i , the current through Z must not be a function of the grid current of the output tube. To satisfy this condition, the voltage delivered by the first section must be likewise constant. The input plate characteristics are designed to maintain a nearly constant value regardless of the changing load. As the effective load-impedance decreases, the plate impedance likewise becomes lower, which tends to produce a constant voltage. The changing load exists as already explained, while the signal is positive.

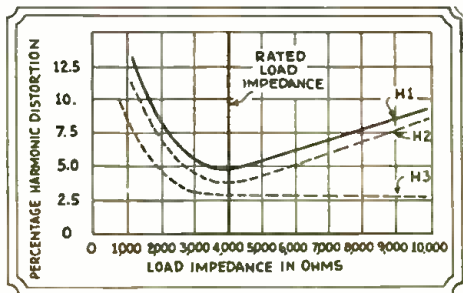

Fig. 4

At rated load, the fundamental output H_1 , is less than 5 per cent. Observe that the output impedance is equal to the tube's impedance.

The spreading and curvature of the plate characteristics are in the right direction to establish a low enough plate impedance for full grid-current compensation. The extra current demanded by the lower grid-impedance is supplied as graphically demonstrated in Fig. 3. On the left of the operating line, the Eg-1p characteristic is shown with a constant load. On the right, this line is approaching the ordinate and its rate is a function of the magnitude of the positive cycle. The shaded area represents grid-current compensation. The grid-current peak is shown as part of a sinusoid. In reality, the non-linear shape of the Eg-1g characteristic alters this form, but the compensation also nearly assumes this irregular shape. From the foregoing analysis, it is evident that the grid bias is not a function of grid current, and therefore, remains steady.

Load Impedance

The proper load for minimum distortion may be equal to the internal impedance which also permits maximum power transfer. The output and distortion characteristics as a function of load impedance approach an ideal condition as shown by reference to Fig. 4. The high-frequency power

(Continued on page 488)



FREE RADIO BOOK~ describes many opportunities to make BIG MONEY in Radio-Talking Movies (Television also Included)

Hundreds of Men Have Won Success This Way

The National Radio Institute is the pioneer home-study radio school. It has prepared hundreds of men for the Radio profession—some of them now holding leading positions in this industry. You'll find N. R. I. trained men in practically every Radio organization of any importance throughout the country. The same practical tested training that enabled these men to get ahead is now open to you. And this training has been improved, enlarged greatly to keep up with the constant expansion of Radio opportunities.

Has Made \$10,000 More in Radio



"I can safely say that I have made \$10,000 more in Radio than I would have made if I had continued at the old job. When I enrolled with you I didn't know a volt from an ampere. I advise all ambitious young men to get into Radio. There is no greater opportunity."—Victor I. Osgood, St. Cloud Ave., West Orange, N. J.

Over \$400 Monthly



"I had 15 years as traveling salesman and was making good money but could see the opportunities in Radio. Believe me I have made more money than I ever did before. I have made more than \$400 each month. I can't say too much for your school."—J. G. Dahlstead, Radio Station KYA, San Francisco, Cal.

Here's a famous book that has shown many a man the way to "cash in" on the big-pay opportunities in Radio. I'm not asking \$5 or \$6 for it—it's FREE. If you're earning a penny less than \$50 a week, mail the coupon below and get a copy of this free Radio book. It will be a revelation to you!

Many Make \$50 to \$100 a Week

Radio—the NEW, uncrowded, growing, live-wire profession—needs many trained men for its good jobs every year. Television, Talking Movies, Aircraft Radio, Radio Servicing and Merchandising, trans-Atlantic Radio Telephony and many other opportunities are thoroughly covered by N. R. I. training. Each one means more big-money opportunities for a trained Radio man. My book gives the facts about these Radio opportunities. And more—it tells how you can get all the training you need, quickly and easily in your spare hours at home, by my new and practical methods. In a short time, through my training, you will be prepared to take advantage of these big-money Radio opportunities. My Free Book will give you all the facts and proof of what I have done for hundreds of other men.

Extra Dollars for You Almost at Once

Think of making \$15, \$20, \$30 extra each week "on the side," without interfering with your regular job! I'll show you how to do that, too, by using spare time that you're wasting now. I'll show you how to turn what I'm teaching you into cash almost at once, when you and I get started together. My Free Book tells you all about it. If you send for the book today, and if you have the average man's ability, it's possible for you to be making extra money in less than thirty days from now. And you can be ready for a good full-time Radio position after eight to twelve months of spare-time training.

I'll Send You This Big NEW 64-Page Book FREE

My book is filled with photos and facts—the pay-raising facts you want to read. If you're interested in Radio, or if you're interested in making more money, you owe it to yourself to read this book. The book absolutely won't cost you a cent, and you place yourself under no obligation by sending for it. No previous Radio experience needed to take advantage of this offer. No special schooling required. Fill in and mail the coupon NOW!

Address **J. E. SMITH, President**
National Radio Institute, Dept. 2BXA, Washington, D. C.

J. E. SMITH, President,
National Radio Institute,
Dept. 2BXA, Washington, D. C.

Dear Mr. Smith: Kindly send me a free copy of your famous 64-page Radio book, which tells all about the big pay opportunities in Radio, Talking Movies, Aircraft Radio, Servicing and Merchandising, and those coming in Television, and how you can train me at home to take advantage of them. I understand this places me under no obligation and that no salesman will call.

Name.....
Address.....
Town.....

Mail coupon Today!



SERVICE MEN

SEND for THIS BOOK YOU NEED IT

FREE!

1932 PRICE GUIDE
Radio Supplies—Tubes—Sets

Every item you require in your business is in this book, from the finest high grade mike to the smallest screw.

GUARANTEED QUALITY GOODS
Prices Lowest Ever Quoted

Fresh new dependable Merchandise at Bargain Prices!

Leading Manufacturers Lines Complete
Send For Your Copy Now!

SAMPLE BUYS FROM THIS BOOK



\$14.65
4-Tube Receiver



\$1.98
Replacement Transformer



69c
500V-8Mf Dry Cond.

and Three Thousand Other Bargains

HEADQUARTERS
for SERVICE MEN'S SUPPLIES

RADOLEK CO.

601 W. RANDOLPH ST.

CHICAGO, ILL.

USE THIS CONVENIENT COUPON

Radolek Co.,
102 Canal Station
Chicago, Ill.

Please send me without obligation your Service Man's Supply Book.

Name _____
Address _____
City _____ State _____

NEW TUBES FOR OLD

R.F. VARIABLE-MU PENTODE

(Continued from page 486)

application as the *first-detector* in a super-heterodyne, and may be used to advantage in this position; the control-grid bias may or may not be made variable. With variable bias on the first-detector the peak oscillator voltage should be made about one volt less than the minimum grid bias (approximately seven volts). This practice will eliminate the possibility of the first-detector drawing grid current causing cross-modulation, which the tube is inherently supposed to minimize. With a fixed bias, the peak oscillator bias should be considerably less than the grid bias in order to prevent grid current flowing and causing grid distortion.

It should be noted that by varying both the first-detector grid bias and the R.F. and I.F. biases, additional control is secured.

Because of the advantages in faithful and well-controlled amplification which have heretofore been difficult to obtain, we can well expect the new lines of automotive and D.C. line-operated receivers to be closer in performance to the well-equipped A.C. re-

ceiver than ever before.

This tube should also find special favor with short-wave experimenters who are endeavoring to sound out the possibilities of receiving in the neighborhood of five meters. The very low input capacity (3 to 4 mmf.) and the almost negligible plate-grid capacity (.0025 of 1 mmf.) open a new field for investigation.

Operating Characteristics

The operating characteristics are as follows: Filament potential, 6.3 volts (D.C. only); filament current, 0.3-amp.; plate potential, 90 to 135 (180 max.) volts; screen-grid voltage, 90 volts; control-grid voltage, 3 volts; plate current, 4.5 ma.; screen-grid current, 1.7 ma.; plate impedance, 300,000 to 680,000 ohms; amplification factor, 285 to 700; mutual conductance 950 to 1050 micromhos, mutual conductance at 40 volts bias, 1 micromho.

A circuit diagram incorporating this new tube is illustrated in Fig. A, the constants for which are included in the diagram.

THE TRIPLE TWIN

(Continued from page 487)

losses caused by increased impedance of the dynamic speaker are less than in triode operation and therefore produce a flatter overall frequency characteristic. This feature will allow a greater latitude for speaker designs and will eliminate the necessity of certain resonant peaks for obtaining high register.

television and special applications is shown.

Power Sensitivity

The power sensitivity is high due to the no-loss effects in direct coupling and the high gain in both the input and output sections. The effective grid area of the output section may be large, as the plate current is not limited by a strong negative field. This allows high amplification with a low plate impedance.

The usual problem when employing high-gain tubes, that of eliminating grid to plate coupling, becomes small as the high overall gain is divided between the two sections. For the first section, the value of the bypass condenser is small. Although the gain in the last section is greater than in a power triode, the bias resistance value is less. Consequently, the capacity for effective bypassing can be directly compared with triode operation.

This tube was designed in the laboratories of the Cable Radio Tube Corporation.

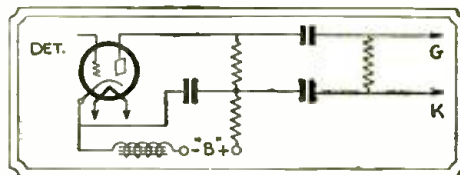

Fig. 6

Suggested diagram for a television amplifier. Since there is no phase shift, the triple-twin is especially adaptable for television use.

Some attention must be given to the shunt resistance R_c which is the effective load-impedance of the first tube. This value controls the peaks of harmonic distortion throughout the power output range.

Frequency Response

The fidelity of this new tube is good. Figure 5 is typical, and shows that the high register is flat far above the audio-frequency range. The frequency characteristic of the coupling inductance has little effect on the shape of this curve because of the coupling shunt-resistance. The curve was taken with resistance coupling input and a pure resistance output load. Resistance coupling will probably be seldom used in broadcast receivers employing this tube because of their combined detector-amplifier advantages. However, in Fig. 6, a resistance-coupling circuit primarily developed for

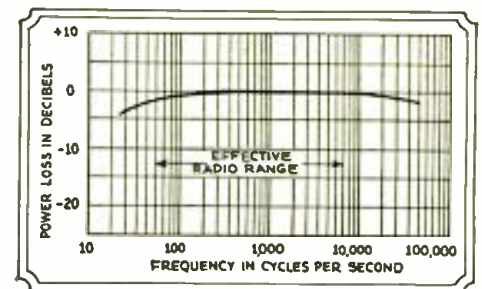

Fig. 5

Fidelity curve of the triple-twin. This curve was taken with a resistive load, but observe that it is flat far above the audio frequencies used in radio communication.



Electrolytic Condensers

Conservative voltage ratings, fastest reforming, lowest leakage factor, minimum noise, exceptionally low power factor, most effective filtering, longest service life — these features characterize Dubilier Electrolytic Condensers.

Available in upright or inverted aluminum cans, and in cardboard containers with lug or wire lead terminals. In single and multiple section units, and in capacities up to 20 mfd., for high and for low D. C. voltages.

Write for Catalog 121 describing Dubilier electrolytic condensers as well as paper, mica and other dielectric condensers for all purposes.



Dubilier

Condenser Corporation
4377 Bronx Blvd. New York City

GRAND ISLAND MONITOR STATION

(Continued from page 461)

acres of ground surrounding the buildings. This acreage has been landscaped and in a few years should be one of the beauty spots of Nebraska. The Stars and Stripes floating from a seventy-foot flag pole in front of the main building advertises the fact that this is a Federal institution.

The numerous fifty-foot poles and the antenna network supported by them have been recognized as a definite hazard to aircraft. For this reason, a sixty-foot tower with a 2-million candle power revolving red beacon mounted on top, has been erected on the grounds. A white course-light pointing directly to the local airport is mounted just below the red beacon.

Every effort has been made in constructing the station to eliminate inductive interference. All motors used at the station are of the induction type. All power leads are shielded. Copper mesh is incorporated within the walls, ceiling and floor of the motor-generator room. All outside power leads are underground. The telephone cable enters the station through nearly 3/4-mile of underground duct. This is a 26-wire cable and furnishes ample facilities for local and long-distance telephone communication.

The Sequence of Measuring Station Frequencies

Each measurement goes through four operations before it is turned in to the office. First, the station must be intercepted and identified by the receiving operator; second, the measuring sheet goes to the measuring booth where the station is measured and the sheet stamped in order of its submittal; third, the final results must be calculated; and fourth, the entire sheet is checked.

All the sheets from one day's watch are turned in to the office the following morning and made up into a report sheet, which is sent in to the Radio Division at Washington.

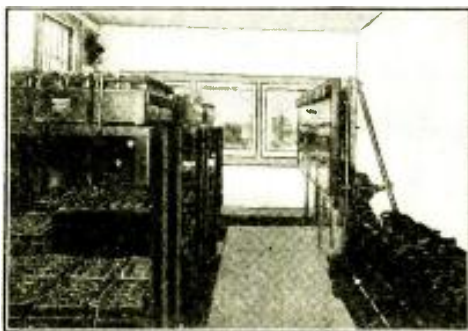

General view of the battery room of the U. S. Monitor Station at Grand Island, Nebraska. The room is well ventilated in order to allow the fumes that are generated, to escape.

Already the needs of the plant have outgrown its present size. Many more directional antennas are needed if the station is to give the same service to all parts of the country. This necessarily means more land,

more receiving equipment and more personnel. A high power short-wave transmitter is needed for more rapid reporting of frequency deviations. The station must

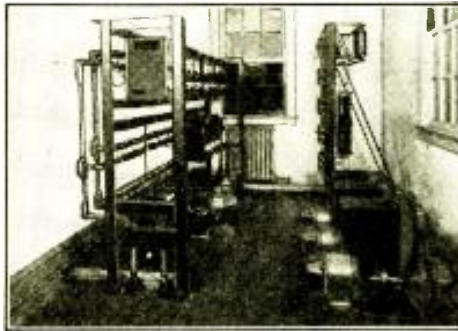

Distributing panel in one of the generator rooms at Grand Island. The generators used for charging the batteries are shown to the right of the picture.

grow and change as the radio art grows and changes. With proper support, the future of the station is bright.

Uses of the Station

The station is designed primarily for the purpose of checking the transmitting frequencies of all the broadcast stations in the United States, as well as a considerable number of foreign broadcasters. Aside from its routine task, Grand Island performs numerous other special services for the Government. It is prepared, for example, to report on radio transmission in practically any country on the globe.

Station wavelengths are measured against the Standard Precision Clock which is mounted in a vacuum chamber in a ten-ton concrete column. The Precision Clock corresponds to the standard pound, the standard foot, the standard quart, etc., in Washington, and is law to the broadcasters. Its pendulum makes one complete swing in two seconds, or covers one-half cycle in one second. This frequency is multiplied through a tuning fork and vacuum tube amplifiers to 30,000 cycles per second, from which harmonics are produced and selected to match the lowest or highest radio frequencies in commercial use.

While reception is taking place careful notes are made of weather conditions, harmonical pressure, and other items which tend to furnish information on transmitting conditions. Approximate signal strengths are noted as well as any other characteristics of the received signal. By reason of this information, it is expected that transmitting conditions under given circumstances will be predictable, and that it will be known, in a general way, what stations can be received under certain conditions and at what times reception will be at its best.

In the second part of this article, which will appear in the March issue of RADIO-CRAFT, the antenna system and all other available information concerning this interesting station will be given.



“Sitting on top of the World”

Permanent success in radio work—as in other things—comes from “making good”—not just “getting by.” Making good means protecting your skill and experience with equipment second to none. Radio men who challenge 1932 with the newest SUPREME INSTRUMENTS are literally “sitting on top of the service world”—abreast—ahead—of radio’s swift strides. No true service man can resist the combination of simplicity and versatility of the Supreme “master” instrument—the complete answer to every service riddle, namely

SUPREME DIAGNOMETER AAA 1

\$147.50

5 ultra modern testing instruments in 1 at the price of 1



Buy no instrument until you have sent the coupon for fullest information on AAA 1 and the other new 1932 SUPREME INSTRUMENTS, viz.:

Model 90 Supreme Set Analyzer	\$78.50
Model 60 Supreme Oscillator	30.00
Model 70 Supreme Oscillator	49.75
Model 40 Supreme Tube Tester	30.00

All Dealers' net prices F.O.B. Greenwood, Miss. Is Your Jobber to Demonstrate

FOREIGN DIVISION

130 West 42nd Street New York City
Cable Address, Lopreh, New York

SUPREME INSTRUMENTS CORPORATION
425 Supreme Building,
Greenwood, Mississippi.

Please send me full particulars on:

.....
(Here indicate instrument or instruments interested in)
Name
Address
City State.....
Name of Jobber
City State.....

THE NEW EMC Simplicity Test Probe Precision Made

The new EMC "Simplicity Test Probe" for service men, dealers, and experimenters is a fast, efficient testing device of vest-pocket size. Users agree that it locates defects in radio sets at a great saving of time and money.

The Simplicity Test Probe locates open or shorted by-pass and filter condensers, burned-out resistors and wiring, breaks in tuning-coil windings, and shorts in variable tuning condensers; also checks presence of filament or heater voltage and correctness of tuning coil polarity. It tests continuity of all low resistance windings and resistors.

Described below are two uses which make this instrument worth many times its price.

To use as a visual indication of tuning condenser alignment and circuit resonance, and to insure a high degree of set output efficiency, place the probe across the speaker voice coil, and adjust the volume control for minimum illumination of the lamp. Next adjust tuning condensers individually for maximum brilliancy of lamp, and again reduce illumination using volume control. When further adjustments result in no increase in illumination lamp, the radio set is adjusted for its most efficient operation. The probe becomes a very efficient trouble lamp when you fasten its clip to one side of a radio filament supply and run a wire from the probe point to the other. And it is only \$1.50.

The EMC Simplicity Test Probe is made of a polished red and black dielectric material neatly engraved in gold. It is exceptionally attractive and professional; a real quality product. Guaranteed and comes complete with standard lamp and full instructions. The size is 7/16" x 7".

\$1.50
Net

Sales at the reduced price of \$1.50 are now made direct from the factory. Send only money orders, express company checks, or cash to us and get one of the most valuable testing instruments on the market today. The net price outside of the U. S. is \$2.00 at Boston.

IMMEDIATE DELIVERY

ELECTRICAL MANUFACTURING CORPORATION

10-6 High Street Boston, Mass.

Study RADIO in CANADA



Earl Kelso

Before he enrolled with Radio College of Canada, Mr. Kelso knew nothing about radio. That was two years ago. Today he is his own boss with a shop at 2374 St. Clair St. W., Toronto, with an efficient Sales and Service organization.

Business is good, Mr. Kelso says, and he thanks Radio College for the personal interest they take in every student.

DAY, EVENING and HOME STUDY Classes

Leading manufacturers in U. S. A. and Canada approve the radio course as offered to students of this College. It is complete, new, thoroughly practical. Free Employment Service definitely assists you to start in business for yourself, or get employment as engineer, inspector, tester, salesman, etc. Write for free booklet.

RADIO COLLEGE OF CANADA

Limited

310 YONGE STREET TORONTO

LATEST IN RADIO

(Continued from page 464)

A special three-prong socket is necessary for its use, two of the prongs connecting to the elements of the cell, while the third is used merely for the purpose of keeping the polarity of the applied voltages the same if the cell is replaced after it has been removed. Two methods of connecting the Bridge are shown in Figs. 11A and B; the values for the component parts being indicated on the diagram.

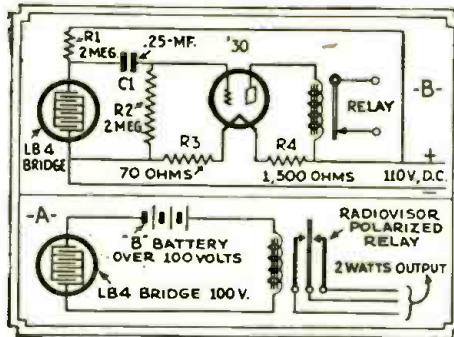

Fig. 11

Two circuits for the Radiovisor Bridge.

The Bridge is uniformly sensitive over almost the entire light band, and hence its output will not vary greatly with changes in the color of light used. The relation between current output and light intensity on the cell is quite linear, and the voltage across the cell falls off rapidly as the modulated frequency of light on the cell increases.

It is a product of the Burgess Battery Co., Chicago, Ill.

A HIGH INTENSITY SEARCHLIGHT

The new searchlight, a development of the Westinghouse Electric & Mfg. Co., is operated from an ordinary storage battery. The light is so intense that a newspaper can be read at distances of five miles; it is visible 50 miles.

DISSECTING TESTERS

(Continued from page 465)

oscillator is very simple and is outlined as follows:

Sequence of Operations

1. With the Diagonometer properly adjusted to the A.C. power supply, throw the "Oscillator-Tube Tests" toggle switch to the "Oscillator" position. The adjacent pilot light, which is connected in series with the oscillator tube filament, should be illuminated;
2. Insert the red dummy-antenna pin plug into the "Ant." pin jack of the Diagonometer's oscillator;
3. Insert the black dummy-antenna pin plug in the red "Gnd." pin jack of the oscillator;
4. Attach the "+" dummy-antenna clip to the "Antenna" binding post of the radio receiver, or to a contact point specified by the radio manufacturer;
5. Attach the remaining dummy-antenna clip to the "Ground" of the radio set;

Experimental Equipment Given FREE to Every Student!



Size of Cabinet: Height, 22 1/2", Length, 17 1/2"; Weight 25 lbs.

We give to every student without additional charge his chemical equipment, including fifty pieces of regular standard laboratory apparatus and supplies and forty-two different chemicals and reagents.

Opportunities in Chemistry



Dr. T. O'Connor Sloane

Chemistry offers those who are ambitious and willing to apply themselves conscientiously, the greatest opportunities of any vocation today. Industrial firms of all kinds pay tempting salaries to get the right men. Opportunities abound on every hand. You can study Chemistry under the well-known instructor, T. O'Connor Sloane, A.B., A.M., Ph.D., LL.D.

You Can Learn at Home

Our home study course, written by Dr. Sloane himself, is practical, logical and remarkably simple. It is illustrated by so many experiments that are performed right from the start that anyone can thoroughly understand every lesson. Dr. Sloane will, in addition, give you any individual help you may need in your studies.

Easy Monthly Payments

The tuition is very low, and includes your laboratory outfit—there are no extras to buy with our course. You can pay in small monthly amounts, and we show you how to earn the cost of the whole cost as you go along.

CHEMICAL INSTITUTE OF NEW YORK, Inc.

HOME EXTENSION DIVISION
19 Park Place New York, N. Y.

Mail the Coupon NOW!

CHEMICAL INSTITUTE OF NEW YORK.

Home Extension Division
19 Park Place, New York, N. Y.

Please send me at once, without any obligation on my part, your free book "Opportunities for Chemists," and full particulars about the Experimental Equipment given to every student. Also please tell me about the latest reduction in tuition price and your easy plan of payment.

NAME

ADDRESS

CITY STATE.....
RC-232

6. Turn the radio receiver's power supply switch "On." As the tubes in the chassis attain their normal operating temperature, adjust the "Oscillator-Output" and receiver volume controls while tuning the oscillator and radio set to the desired frequency for any receiver adjustment which may be necessary;

7. If it is desired to make the adjustment by output meter indications, turn the power-pack switch "Off," insert the push-pull power tubes (when, for instance, the output tubes are used in this manner) in the plate-lead-adapters, and replace the tubes (with the adapters attached) in the push-pull power tube sockets;

8. Insert the plate leads of the adapters in the "+ Output" and "0-1000 Volts" pin jacks, and set the "Scale Selector" at "1000";

9. Throw the "Ohmmeter-Multi-Meter" toggle switch to the "Multi-Meter" position, and connect a suitable conductor between the "Multi-Meter Common" and "- Output" pin jack;

10. Turn the power supply switch "On." As the tubes in the chassis attain their operating temperature, adjust the "Scale Selector" for a "Multi-Meter" deflection at, or below, two-thirds of the full scale deflection. The "Multi-Meter" deflections will be arbitrary, and should not be interpreted in the values marked on the dial;

11. Make the proper tuning readjustments on the radio under test for maximum output readings, resetting the "Scale Selector" whenever necessary to keep the "Multi-Meter" needle from going off scale. During the "Multi-Meter" indications, the oscillator signals should be audible from the loud-speaker; failure to hear the signals which are indicated by the "Multi-Meter" would be an indication of defective output transformer or speaker circuits;

12. After completing the adjustments, turn the set "Off," disconnect the oscillator, remove the adapters from the tubes, and return the power tubes to their proper sockets. When using the oscillator portion of the Diagonometer with receivers having only one power tube, of course only one of the adapters is required, with the plate lead connected to the "0-1000 Volts" pin jack, and with a test lead connected between the "Output" pin jack and the grounded chassis of the set under test. If the operator finds it more convenient, the "0-1000 Volts" and "+Output" pin jacks may be connected across the voice coil terminals of the radio receiver under test; otherwise, the procedure is similar to that outlined above.

Tuning Ranges

The oscillator incorporated in the Supreme Diagonometer is designed and calibrated for universal application for all intermediate and broadcast frequency requirements with multiple tuning of all frequencies between approximately 90 and 1500 kc. (kilocycles).

It is, therefore, adaptable to all present commercial intermediate frequencies as well as such frequencies between 90 and 550 kc. as may be selected for the I.F. tuning of future radio receivers, thereby greatly lessening the probabilities of obsolescence. This design is a radical contrast to the earlier types which provide tuning at only one or two I.F. points and which will become more or less obsolete as new inter-

mediate frequencies are chosen and announced by superheterodyne receiver and converter manufacturers.

This unusual adaptability is accomplished by tuning over a fundamental range of approximately 90 to 250 kc., all higher frequencies being provided in the higher or harmonic-frequency range of this fundamental-frequency band, for the tuning and balancing readjustments of tuned R.F. receivers which operate within the American broadcast range of 550 to 1500 kc.

Unusual tuning selectivity is provided for all broadcast frequencies without sacrificing the apparent broadness which is essential for the "flat-topping" of intermediate I.F. tuning circuits as recommended by some superheterodyne manufacturers. In choosing broadcast tuning frequencies, it is generally advisable to select the desired frequency at a dial setting between 40 and 50, where the curve has a slope of about 45 degrees on the calibration chart.

A receiver frequency can be determined with the oscillator by working the oscillator as near the zero setting as possible. The recommended procedure for these determinations consists of setting the oscillator tuning dial at "0" and then moving the oscillator dial from "0" to a point which will resonate the oscillator with the receiver at any arbitrary tuning of the receiver.

This procedure will cause the harmonics of the oscillator to be approximately 250 kc. apart. By noting the oscillator dial setting for the resonant condition obtained by this procedure, the operator will be able to follow the horizontal line from the dial setting on the calibration chart to the curve, thence downward to the frequencies corresponding to the dial setting where it will be observed that his receiver is resonating at one of about five frequencies; and since he will know the approximate frequency of his receiver, that is within 200 or 250 kc., there will not be any difficulty in finding the exact frequency indication which is nearest this approximate frequency.

Vernier-Movement Tuning Dial

The ratio-gearing of the tuning dial is provided for fine tuning adjustments. *Care must be exercised in its manipulation at the "0" and "100" positions so as not to force the movement beyond these extreme positions,* thereby affecting the accuracy of the calibration. By using the vernier-movement tuning dial with which this oscillator is equipped, and with the apparent tuning broadness of the oscillator over its fundamental range, the user will find very little difficulty in varying the tuning of the oscillator the few kilocycles which are necessary for either the "flat-topping" or "staggering" adjustments of the I.F. stages of superheterodyne receivers.

One superheterodyne manufacturer, using an I.F. of 175 kc., recommends that the "flat-topping" adjustments should be between 171 and 179 kc.; that is, an adjustment of 4 kc. either way from the basic intermediate frequency. Service Men should note that at these points on the calibration chart of the Diagonometer's oscillator, each scale division of the oscillator tuning dial represents about 2½ kc. so that 4 kc. may be obtained by moving the dial 1.6 divisions. The fractional division can be very closely approximated by observing the vernier ratio of the dial movement.



Get this FREE Book telling how Centralab Fixed Resistors are made

Just off the press . . . an interesting, handsomely illustrated booklet describing the unique and different process of manufacturing CENTRALAB FIXED RESISTORS. Its yours for the asking . . . send for it.

NOTE: New low prices on Centralab Volume Controls. Effective Jan. 1st, prices have been radically reduced.

Centralab
CENTRAL RADIO LABORATORIES

930 E. Keefe Ave., Milwaukee, Wis.

Mail the Coupon Today

CENTRAL RADIO LABORATORIES
930 E. Keefe Ave. Milwaukee Wis.

Please send me FREE Booklet "A Baptism of Fire"

I enclose 25c for CENTRALAB VOLUME CONTROL GUIDE

Name

Address

City

Province

Radio Craft

FILTERMATIC PRODUCTS

Help you to get the BEST possible reception from your RADIO set.



SUPER-TONE CONTROL

Will make your old Radio (battery or electric) equal in tone to the most modern set. Installed in one minute's time, no tools required. Will tune out much of your noises and so-called static. Will tune your set to suit your ears. Positively cannot harm the finest radio in any way. Price, \$2.50 postpaid. Satisfaction guaranteed or money refunded.

SUPER-FILTERMATIC The Modern Aerial

Thousands of satisfied users, praised by radio experts. Eliminates all other aerials, reduces static, and noise. Especially good on distance reception. Helps to separate stations, does not connect in light socket (therefore eliminating hum and line noises). It is very compact, measuring only 1 1/2 x 2 inches, is absolutely non-corrosive and non-directional. Installed in one minute, no tools needed. Will never wear out. Eliminates troubles and expense of lightning arrester.



Price only \$2.00 postpaid

Satisfaction guaranteed or money refunded

ALL PROGRAMS are good with a FILTERMATIC. For all radios only \$1.00 postpaid.



Entirely automatic — no bothersome tuning. Improves tone, reduces static, brings in distance. Increases volume, separates stations.

Installed in one minute, no tools required, in series with your aerial or across your aerial and ground. Satisfaction guaranteed or money refunded.

Send check or money order (C.O.D. 25% with order. (No foreign C.O.D.)) Money back guarantee after 5 day trial.

Service Men and Dealers Write for Particulars, also information about FREE local newspaper advertising service.

FILTERMATIC MFG. CO.

(Dept. B-9) 4458 Frankford Ave., Philadelphia, Pa.

**RADIO DEALERS
RADIO SERVICEMEN
NEW**

Radio Handbook

CONTAINING:

- Technical Information.
- Volume Control Guide.
- Transformer and Condenser Guide.
- Radio Replacement Parts Catalog.

Sent postpaid anywhere for only **25 Cents**

Specials from our Catalog

Atwater Kent 37 Transformer, ea. \$2.95

Atwater Kent 37 Block with chokes)
Majestic Super "B" Eliminator Block (\$2.25
Electrolytic 2 anode Condenser, ea.)

Hard to Get Parts—We have them. Send us your Repair work for estimate.

Grant Radio Laboratories

6521-C South Halsted Street, Chicago, Ill.

DEALERS—AGENTS WANTED



EVERYWHERE, to handle the fastest selling radio attachment on the market today.

THE POLICE LOWWAVE CONVERTER

A new invention that is easily attached to any radio — by means of which anyone can tune in, at any time on local police broadcasting and get such thrilling — exciting — and often sensational items as headquarters puts on the air for Radio-Police squads. Simple instructions are furnished.

SELLS FOR ONLY \$3.00

Send \$1.79 for sample, no stamps. Or if you wish, send 10c in stamps for C.O.D. order and pay postman the balance of \$1.69.

POLICE LOWWAVE LABORATORIES
1460 Huron St. Dept. 10 Toledo, Ohio

A V. T. VOLTMETER

(Continued from page 466)

laboratories. The instrument which is described in the following paragraphs and illustrated in Figs. A and B, has been made as versatile as possible and has a voltage range for alternating currents of approximately .0005 to 100 volts, or to greater values as desired. It has a D.C. voltage range of approximately .1 to 100 volts or greater if desired. It is designed principally for radio frequency measurements, and is provided with a single direct-coupled R.F. stage. The R.F. tube is placed at the end of a long flexible neck (made from BX cable), thus the name given the instrument—"goose-neck." This is done in order that the connections between the point to be measured and the control grid of the V.T. voltmeter can be made as short and direct as possible to minimize pickup of strays, losses, and resultant inaccuracies.

Batteries

The new automobile tubes, the '36 and '37, lend themselves admirably to this instrument because of their heater-type construction, non-critical filament requirement and the use of a common filament supply. The filament requirement of the '36 and '37 is 6 volts at .3-ampere. The source of supply may be four No. 6 dry-cell batteries. These are placed in a metallic shield-can which is readily constructed from galvanized sheet iron or tin. Some of the larger battery-manufacturers make a 6-volt unit in a metallic container which is satisfactory.

The batteries for plate supply are contained within the housing of the V.T. voltmeter (see Fig. B) and are: two single flashlight cells of 1.5 volts each, two 4.5-volt "C" batteries, and six type 4156 Burgess (or similar size) 22.5-volt "B" batteries. The only other item of real expense, with the exception of the two tubes, is the microammeter. This may be either a Weston or a Jewell, 0 to 200-microampere scale, of the model 301 type. The balance of the materials, with the exception of the switches, will probably be found in the "junk box."

Construction

The container of the V.T. voltmeter is made in four parts: the panel, the socket support, the battery carrier, and the cover. The first of these to be prepared is the panel. This is laid out in accordance with the photographs and the sketch. It is made of sheet aluminum 1/8 in. thick, 4 1/2 ins. wide and 12 ins. long. While aluminum and the size given are recommended, the constructor may use any metal and may change its shape; however, practice has shown that the shape given is more convenient.

The hole for the meter and the hole for the tube-well are next cut out. This may be done with a fly cutter or may be accomplished by drilling a series of small holes around the inner circumference after which the inner portion is removed and the edges filed smooth. Next, drill the holes for the mounting of the potentiometer R2, the bucking-circuit resistance R3, the switches

**S. Gernsback's
Radio
Encyclopedia**

*Second Edition
Contents Entirely New*



- 2,201 Radio Definitions
- 1,253 Technical Illustrations
- 34 Tables and Charts
- 24 Pages of Appendix
- Size of Book: 9 in. wide by 12 in. high
- 352 PAGES
- Weight, 3 lbs.
- Red Morocco-Keratin Flexible Binding
- Printed on strong ledger paper
- Loose-Leaf Arrangement

THIS book is the New Edition of the Famous First Radio Encyclopedia by S. Gernsback, the first book of its kind ever published in America.

The new Second Edition—just off the press—is fully revised, rewritten, and enlarged. It is the absolutely up-to-the-minute new model of the pioneer First Radio Encyclopedia, which became the stand-by of all radio men in every part of the world. Over 39,000 copies of the first edition were sold.

What the New Second Edition Radio Encyclopedia Gives You

It gives you an explanation of every word used in radio. These explanations—or, rather, definitions—are not brief outline information like those of an ordinary dictionary, but they give in fullest detail, and at considerable length, the meaning and application of every word, phrase, general and special term used in the science of radio. They are written in plain, everyday English, easily understood by anyone.

Practically every definition in the book is illustrated by drawings, photographs, diagrams, or charts. All you need to do is to look up as you would in a dictionary, the word or phrase about which you are seeking information. Furthermore, each page is key-indexed, for greater convenience and speed in locating any definition. All the Subject-Matter is Arranged in Alphabetical Order.

This greatly enlarged Second Edition Radio Encyclopedia is an absolute necessity to everyone interested in Radio. It answers all radio questions, increases your knowledge and saves your time. It covers every known radio problem, and is a goldmine of practical information for every radio man.

Mail Coupon Today!

S. GERNSBACK CORPORATION. RC-232
98 Park Place, New York, N. Y.

Send me one copy of the new Second Edition S. Gernsback Radio Encyclopedia. I enclose herewith \$3.98, check or money order preferred. (Foreign and Canada, add 35c extra for postage.) Money refunded in full if not satisfactory.

Name

Address

City..... State.....

SW1, SW2, SW3, SW4, and the three holes for the binding posts. The hole for the insertion of the gooseneck or BX is next drilled. The size will depend upon the size of the BX. The BX should be large enough to place six leads through; one, the plate lead, is shielded. After these holes are drilled, a series of smaller holes is drilled around the edge of the panel at equi-distances. These are then countersunk to take a 6/32 flat-head machine screw. These holes are provided to anchor the 1/2-in. angle, aluminum or brass, which is made into a rectangular frame and fastened underneath the panel. The details of this construction are shown in Fig. B.

The socket support is next prepared. This may be any kind of material but aluminum is recommended as it is easier to work. It is 1/16-in. thick, 2 ins. wide, and 6 1/2 ins. long. It is suspended from the panel with threaded rods 1/8-in. in diameter and 1 1/2 ins. long. In addition to this support, the socket panel is fastened to the microammeter, taking care that the terminals of the meter are insulated from the metal.

The battery carrier is next made, and in turn may be made of any metal of such thickness as to be sufficiently rigid. It is cut and bent as detailed in Fig. B.

Making the Gooseneck

The gooseneck, as it has come to be called, is made of three parts, exclusive of the six leads that pass through the BX. The parts are: a length of 1/2-in. (or even larger if desired) BX hollow tubing, an empty "Mennens" talcum powder (for men) can, and a Pilot type 217 molded bakelite socket or one of similar size or shape. The top of the talcum powder can is pried off, care being taken not to bend or disfigure either the can or the top. The perforated end of the top is drilled out to pass the BX tightly. The BX is then soldered firmly to the top. To remove the paint or enamel

now soldered to the other end of the BX. The six leads are now provided, one of which should be shielded with woven wire braid. These are passed through the BX. The leads are then soldered to the rivets or eyelets of the Pilot socket and the extending prongs of the socket are removed. It is recommended that colored leads be used as this will prevent confusion and a great deal of testing. The socket is next fastened to the top of the gooseneck making sure there is clearance between the socket and the sides to allow the can to slip into place. The bottom of the can is drilled with a 1/2-in. drill to accommodate a rubber grommet. Five leads are soldered to the socket; the extra lead, which is the grid return, is brought through the top of the talcum powder can, just under the socket. The end of the lead is then provided with a battery clip. A control-grid clip of the cap type is also provided with a battery clip.

The gooseneck is next fastened to the panel, leaving the leads sufficiently long to reach to the various switches and parts. The socket panel and meter as well as the other parts are mounted, and the instrument is wired as shown in Fig. 1. Care should be exercised in wiring as the time expended will amply repay the constructor. The "C" batteries are held in position with brackets, and connections are made to them by soldering direct, or by soldering screws to the batteries, after which the leads may be connected with lugs and nuts.

The feed resistor R1, is soldered direct to the BP2 binding post. The bypass condensers C1, C2, and C3 are soldered direct to the top of the battery carrier, which in turn, after wiring is complete, is fastened to the angle on the underneath of the panel. The details of the cover are given in Figs. A and B and will not be explained here as it is simple of construction. It is made, however, to fit over the angle sides of the top.

Calibration Procedure

The insertion of the binding posts on the panel and the switch SW1, which will be noted is a three point single-throw switch, allows the operator to switch out the amplifier tube and to use the tube V2 alone as an ordinary V.T. voltmeter. This arrangement also allows the operator to extend the range of the instrument to any scale desired, by the use of an external voltage multiplier which is described in a later paragraph.

The instrument is first calibrated across the binding-post terminals. Either of two methods of calibration may be used as shown in schematic form in Figs. 2A and 2B. That of Fig. 2A is recommended. In either case, an A.C. voltmeter, having a maximum voltage scale of 3 volts, and a filament transformer with a winding of 2.5 volts are required. The resistor R, Fig. 2A, is a known resistance and is more convenient if in the form of a decade resistance box, although this is not necessary. The V.T. voltmeter is placed across the terminals 1 and 2 and is then calibrated. The voltage drop across the resistor R1 is the ratio of $R1 \times E$, divided by $R1$ plus R , in which E is the reading of the voltmeter. The voltmeter is thus calibrated over its entire range by varying the ratio between $R1$ and R and by simple calculation.

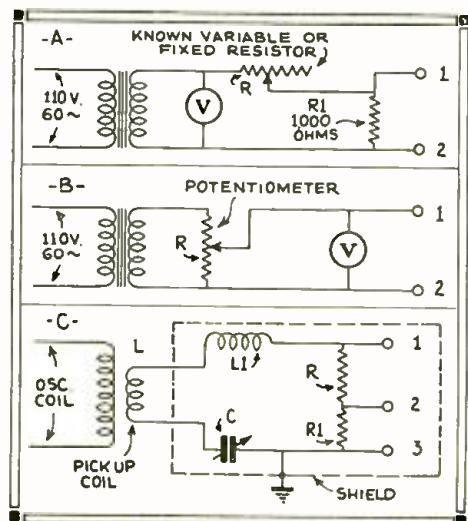

Fig. 2

Three methods of calibrating the voltmeter are shown at A, B and C. Any one may be used, depending upon the apparatus on hand.

from the can, hold it over a gas burner until the enamel is burned nearly off, then finish the job by rubbing with steel wool.

Next, a disc of brass, copper, or iron 1 1/4 in. in diameter is secured. Three holes are drilled 1/4-in. from the edge and equi-distant from each other; these are provided to fasten the neck to the panel. This disc is

Many men who have
BECOME SUCCESSFUL IN RADIO

learned at

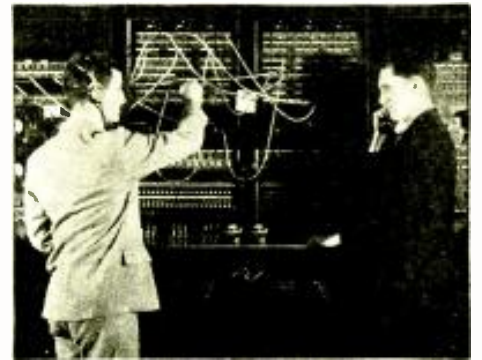

Behind the scenes at a broadcast studio

MORE than 20,000 men have graduated from RCA Institutes, America's oldest radio school. Many of these men now hold responsible positions in all branches of the radio industry. They got their training at the right school. So can you.

RCA Institutes is fully equipped to give you complete training in every branch of practical radio. There are elementary courses for beginners—advanced courses for those who already have some radio knowledge. No "cut-and-dried" lessons—you are enabled to pick the course that exactly suits you.

Learn Two Ways

You may learn radio in two ways . . . either at one of the four big resident schools, conveniently located in New York, Chicago, Boston and Philadelphia. Or, if you prefer, you may study at home in your spare time, through our extension courses. Special home laboratory equipment is furnished. Both types of graduates are eligible for special free scholarships for outstanding work.

Association with the largest research laboratory in the radio industry enables RCA Institutes to keep up with the latest developments. All schools are supplied with the most modern equipment . . . the instructors are men of practical experience. Yet with all these advantages which you get, the tuition is no higher than other schools. Why not write for our latest general catalog, giving full details of any course in which you may be interested? The coupon makes it easy.

A Radio Corporation of America Subsidiary

RCA INSTITUTES, INC.
Dept. RT-2, 75 Varick St., N.Y.

Please send me your General Catalog. I am checking below the phase of radio in which I am interested.

<input type="checkbox"/> Aircraft Radio	<input type="checkbox"/> Talking Pictures
<input type="checkbox"/> Broadcast Station or Studio	<input type="checkbox"/> Servicing Home Entertainment Equipment
<input type="checkbox"/> Disc and Film Recording	<input type="checkbox"/> Television

Name.....
Address.....
Occupation..... Age.....

AERO WORLDWIDE SHORTWAVE RECEIVER

\$6.45 Listen in DIRECT to London, Paris, Berlin, Buenos Aires and other broadcasting stations throughout the world via short waves. Your ordinary receiver cannot tune in these long wave stations. **WORLD-WIDE RECEIVER** gets 14 to 550 meters.



AERO SHORT WAVE CONVERTERS
Convert Your Present Set Into a Short Wave Super-Heterodyne

A. C. MODEL \$12.50—D. C. MODEL \$11.50
AT LAST! The Perfect Auto Radio . . . ONLY \$20.00
Built by pioneers in the manufacturing of Auto Radio. We guarantee 1,000 miles radius of reception. A masterpiece of Radio engineering. Latest model 6 Tube Aero Pentode Auto Radio. Price of set only \$20.00. Set complete with tubes, batteries, dynamic speaker, antenna equipment and noise suppressors. \$39.50.

NEW AERO MIDGET

Using the Latest Type Pentode, and Multi-Mu Tubes.
Price . . . \$16.50
We guarantee **COAST TO COAST RECEPTION**



Wonderful tone quality and selectivity. Full dynamic speaker. Full vision dial. Beautiful walnut cabinet. 5 Tube Set \$16.50, less tubes. Complete set of 5 matched tubes \$4.50 extra.

SEND FOR COMPLETE CATALOG
CHAS. HOODWIN COMPANY

Dept. O-15 4240 Lincoln Avenue Chicago, Illinois

ATTENTION DEALERS AND SERVICEMEN

Write now for our new 1932 Radio catalogue. Everything listed at lowest possible wholesale prices.

JOHNSON RADIO MFG. CO.

Tarrytown Rd. Pleasantville, N. Y.

ATTENTION

Set Analyzers, Testers, Tube Checkers Rewired—brought up to date for Pentode and Variable Mu Tubes, no Adapters. Receivers Rewired for Pentode and Variable Mu Tubes.

RADIO SERVICE SHOP

132 Bryant St., N. W., Washington, D. C.



SAVE SERVICE TIME and MONEY

TRUVOLT RESISTORS. with adjustable clips, mean quicker service and fewer parts to stock. All standard sizes.

Write Dept. RC-2 for Folder

175 Varotek St., New York, N. Y.
ELECTRAD

TUBE CHECKER



As shown or "short" tester can be built with our 1 1/2, 2, 2 1/2, 3, 5, 6, 7 1/2 volt 25 watt transformer. Full instructions for building tube checker. Tests ALL modern new tubes also "short element" tester without switches. Trans. \$2.25, shipping wt. 5 lbs. Add P.P.

L & I ELECTRIC CO.
336 Madison Ave., Memphis, Tenn.



\$5,000 WILL BE PAID TO ANYONE WHO PROVES THAT THIS IS NOT THE ACTUAL PHOTO OF MYSELF showing my superb physique and how the Ross System has increased my own height to 6 ft. 3 3/4 inches. Hundreds of Testimonials. Clients up to 45 years old gain from 1 to 6 inches in a few weeks!



First In 1907 First To-day

No Appliances—No Drugs—No Dieting. **ROSS SYSTEM NEVER FAILS.** Fee Ten Dollars Complete. Convincing Testimony and Particulars sent stamps. Allow time for return mails across the Atlantic. **G. MALCOLM ROSS, Height Specialist,** Scarborough, England, (P. O. Box 15).

The method shown in Fig. 2B, while not as accurate, is satisfactory. A potentiometer R is placed across the filament winding of the transformer with the A.C. voltmeter connected across one side of the transformer and to the arm of the potentiometer. The V.T. voltmeter to be calibrated is then connected across the A.C. voltmeter at terminals 1 and 2. By adjusting the position of the potentiometer arm the voltage may be varied and the V.T. voltmeter calibrated accordingly. The resistance value of the potentiometer may be 200, 400 or 1000 ohms, the higher value giving the smoother adjustment. After the tube V2 has been calibrated, the instrument may be calibrated on radio frequencies, using the arrangement given in Fig. 2C.

A radio frequency oscillator, a pickup coil L in series with coil L1, the tuning condenser C, and the resistors R and R1 are required. The oscillator should be calibrated over the band of frequencies to be used in the calibration of the V.T. voltmeter. The resistance R should be 49 ohms and the resistance R1, 1 ohm. This will give a ratio of 50 to 1. The resonant circuit consisting of L, L1, C and the resistors R and R1 is now placed in resonance with the calibrated oscillator. With an ordinary V.T. voltmeter, or using only the section comprising V2 as has been described, the voltage is measured across terminals 1 and 3.

Suppose that the current flowing through the resonant circuit is 4 milliamperes, then the voltage across terminals 1 and 3 will be .2-volts. The voltage across the 1-ohm resistor will then be .2-volt divided by the ratio which is 50, giving a voltage across terminals 2 and 3 (the 1-ohm resistor) of .004-volt.

Thus, the V.T. voltmeter with the amplifier tube V1 is calibrated over its entire scale. The instrument should be calibrated at various radio frequencies in order that the amplifying characteristics of the amplifier tube will be known. It is important that the voltage across terminals 2 and 3 be kept constant at .004- or .005-volt during this test, by checking the voltage across terminals 1 and 2 at frequent intervals. While the section comprising V2 of this instrument may be used for this purpose, it will be found more convenient to use a separate V.T. voltmeter, which may be only a temporary affair.

The Voltage Multiplier

This device is shown in schematic form in Fig. 3. It consists of four resistors: one 900,000-, one 80,000-, and two 10,000-ohm resistors connected in series to give a total resistance of one megohm. Taps are brought to a multipoint switch as shown. With the resistors arranged according to the illustration, point 1 will have a ratio of 1:1, point 2 will have a ratio of 10:1, point 3 will have a ratio of 50:1, and point 4 will have a ratio of 100:1. Thus, if the input terminals of the device are connected to a source of voltage between 50 and 100 volts, and the output terminals connected to the V2 section of the V.T. voltmeter, the voltage indicated when multiplied by 100 will give the correct value. Thus, if the voltage read on the meter is .9-volt, 100 times this would give 90 volts across the input terminals of the multiplier. It must be remembered that the input voltage to the voltmeter tube must

not exceed 1.0 volt effective value. If the control grid of the voltmeter tube becomes overloaded, grid current will flow, causing a shift from the linear portion of the characteristic with resultant inaccuracies in the voltmeter reading.

Placing the Voltmeter in Operation and Adjustments

Before the instrument may be calibrated, it is necessary that the voltages of the tubes be properly adjusted. The voltages of the

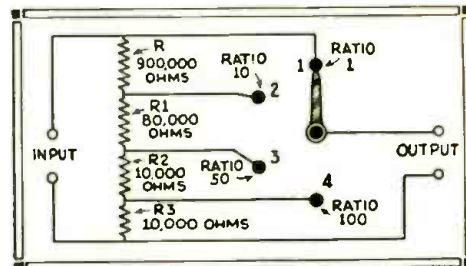

Fig. 3

A multiplier that facilitates increasing the range of the voltmeter 100 times.

tube V2 are first adjusted. The terminals BP1, BP2, and BP3, Fig. 1, are first shorted. The switch of the bucking battery circuit is opened. This is SW4. The plate voltage of V2 and the bias voltage (the latter adjusted by the potentiometer R) are adjusted so that the current indicated on the micro-

(Continued on page 495)

IMPROVING OPERATION

(Continued from page 476)

I have wired several of these machines and in each case the volume was the same, or greater, than with the type 701A tubes; although the type 731 tube will not handle as much power as the 71A, it will give good room-volume. The "B" drain, using 2-volt tubes, is only one-half as much as before.

(The circuit of the original A.K. "33" and "49" is shown on Data Sheet No. 17, which appeared in the May, 1930 issue of RADIO-CRAFT.—Tech. Ed.)

SERVICE FORUM

(Continued from page 476)

this apparent discrimination has caused some comment. The above letter from the Atwater Kent Manufacturing Company should lift the veil of secrecy that has surrounded this question, for all times.—Editor.)

BUYING MOTIVES

DEPLORING the prevalent practice of price-cutting, Harry T. Bussman, of the Bussman Mfg. Co., at a conference of radio dealers, voiced six buying motives (and stressed the last four as contributing to economic recovery) which every radio Service Man and technician should memorize; for they are the fundamentals of selling, regardless of the product, to wit: gain of money, gain of utility, satisfaction of caution, satisfaction of pride, gratification of pleasure, and gratification of sentiment.

BOOK REVIEW

MAGNETIC PHENOMENA; by Samuel Robinson Williams, Ph.D., D.Sc., 230 pages, cloth bound, 6 x 9 inches, 150 illustrations and numerous tables. Published by McGraw-Hill Book Co., Inc.

The serious radio experimenter and Service Man will find this volume most interesting.

The operation of every magnetic device, such as electric motors, coupling coils, magnetic and dynamic loud-speakers, transformers, choke coils, etc., is all dependent on the knowledge that magnets and magnetic devices will act in certain unvarying ways under given conditions.

Considered from the viewpoint of the research worker, this book is as complete a source of data as possible in one small volume. The nature of the subject, however, necessitates a complete mathematical treatment and for this reason, a working knowledge of algebra and calculus is needed to derive the greatest benefit from it.

The volume is divided into eight parts, each comprising one phase of the question.

The first is called Magneto-Magnetics and deals with the elements of magnetic action, both for natural and electrical magnets; the second section deals with that interesting, and until recently little used, action called Magneto-Striction, or the mechanical change in shape of certain metals when placed in a strong field. Next are considered Magneto-Acoustics, covering the production of sound by magnetization and the effects of sound waves on magnetic fields; Magneto-Electrics, the development of electric fields and currents by varying magnetic forces; Magneto-Thermics, the effect of heat on magnetic phenomena and the converse effects; Magneto-Optics, the Faraday Effect and other optical changes due to magnetic fields; Cosmical Magnetism, dealing with the earth's magnetism, and the effects of magnetic action from the Sun and other planets; and finally, Magnetic Theories and Experimental Facts, covering a brief history of magnetic theories and action.

It is impossible to explain in greater detail, in this small space, the scope of this publication. We can however, recommend it as one of the best reference books available on this fundamental subject. (C.W.P.)

ME AND LITTLE RADIO NR11 (Second Edition); by Amando Cespedes Marin; 272 pages, leather or paper, 6 x 9 inches, 22 illustrations. Published by Amando Cespedes M. Price, \$3.50, leather bound; in paper, \$2.50.

Do not fail to read this educational, amusing, enchanting and entertaining book by the owner of 7½-watt, short-wave radio station NR11, or to use the official call, "FI-4 NR11, Heredia, Costa Rica, South America. Be sure to follow his peregrinations through the Radioland of his own making (conceiving, constructing and operating world-famous radio station NR11), as he journeys in the company of his friend Mr. Fernandez, who seems to have taking ways.

In his preface the author states, "I could had the book typescript revised by an english literary man, but then half of the work would be result of little importance, for it is amid its queerness that you will reap the sweetness of its lively narrations."

This thoroughly original and captivating literary style prevails throughout the entire book.

We cannot resist the temptation to quote just three more paragraphs from his book,—the opening paragraphs on the initial page of the first chapter which is entitled, "My first listening."

"Back in November 1923, when our dry season winds are blowing and on the time when everybody thinks of those persons gone forever to some far beyond—an old friend of mine,—the ardent fan Mr. Vicente Fernandez, a real amateur listener and radio developer in this country, invited me to listen to special broadcasting which were going to take place that night.

"Radio then, were at its beginning down-here, and not obstant that I never had heard music or a talk by the air, I went to his home to hear, what my own hands had made for Mr. Fernandez,—the real voice, out from one five inch diameter coil,—hooked up in a regenerative circuit of the first radioplans published in 'Radio News' by Hugo Gernsback.

"If you want to live again the experiences of your first days in the radio service and sales field, read Sr. Cespedes' confessions under the chapter heading, "Radio 'Doctor' and pusher." (R.D.W.)

A VACUUM-TUBE VOLTMETER

(Continued from page 494)

ammeter is 10 microamperes. The switch SW4 is now closed and the variable resistor R3 is adjusted until the current read on the microammeter is 2 microamperes. The use of the bucking battery arrangement allows greater sensitivity of the V.T. voltmeter with greater accuracy, as it cancels out the steady plate-current flow of the tube. After this portion of the instrument is adjusted, the amplifier tube is next adjusted. The only required adjustment here is that of the screen-grid voltage which is adjusted to a value that will give maximum amplification from the tube. The potential will naturally be small due to the drop in plate voltage through the resistance R1. In calibration and measurement work, it is important that the voltmeter be shielded from possible strays as otherwise, inaccuracies will result in the work.

List of Parts

One Weston model 301, 0 to 200 microamperes, or Jewell microammeter, M1;
Three GE or Hart and Hegerman power switches, SW2, SW3, SW4;
One GE or II. and II. three point, single-throw power-switch, SW1;
One Pilot type 217 molded bakelite socket, V1;
One UY type wafer socket, V2;

One Electrad Supertonatrol, 0 to 500,000 ohms, R3;
One Yaxley midget 400-ohm potentiometer, R2;
One Lynch or Accuraohm wire-wound precision resistor, 200,000 ohms, R1;
Three binding posts, BP1, BP2, BP3;
Two Sprague or Aerovox, 1-mf. fixed condensers, C2, C3;
Three Sprague or Aerovox, 1-mf. .1-mf. fixed condensers, C1;
One 12-in. length hollow BX tubing, goose-neck;
One empty "Memmens" talcum powder can, to shield V1;
One aluminum panel ¼-in. thick, 4½-ins. wide, 12 ins. long for panel;
One sheet aluminum 1/16-in. thick, 2 ins. wide, 6½ ins. long, for wafer socket support;
One battery carrier as described;
One sheet tin container; for cover;
One type UY 236 tube, V1;
One type UY 237 tube, V2;
Six portable 22½-volt "B" batteries, Burgess type 4156, B2;
Two 4½-volt "C" batteries, B4, B5;
Two 1½-volt flashlight cells, B1 and B3;
Four No. 6 dry-cell batteries in metallic container for filament supply, B6.

CROSLEY

offers the
Greatest

VALUES
in Radio
at lowest
possible prices



The low Crosley prices attract prospects to your store.

SUPERLATIVE performance at the lowest possible price! This requirement is uppermost in the minds of those who today are

contemplating the purchase of radio receivers. And so in accordance with the Crosley policy of providing what the public will buy, Crosley has set about to meet this demand.

In doing so, Crosley engineers and technicians have left nothing undone to give you, the radio dealer, and in turn, your customers, the greatest and most sensational values that have ever been offered in the radio industry. Consequently, Crosley radio receivers are in demand today. And they are priced so that the radio dealer can operate at a profit — TODAY.

Today's "buyers' market" has put its stamp of approval on the amazing Crosley models. It has professed its satisfaction in terms of greater sales. So perfectly does Crosley reflect the needs, requirements and taste of the radio-buying public that *no dealer can afford not to handle Crosley.*

The Crosley Radio Corporation

POWEL CROSLEY, Jr., President
Home of "the Nation's Station"—WLW
CINCINNATI

YOU'RE THERE WITH A CROSLEY
**CROSLEY
RADIO**

HOW TO MAKE A MICROPHONE MIXER

(Continued from page 467)

sound projectors blast in order to allow people to hear what is going on. The gain should first be advanced until the output level overrides the noise of the audience, who will probably be talking among themselves. As soon as the introductory remarks of the orator have begun, the audience will usually become quiet and begin to listen. The amplifier gain should now be reduced so that when the orator is talking in a normal tone the people in the rear of the assembly can just make out what he is saying. The ear is a most remarkable device, in that it automatically becomes adjusted to the level in sensitivity. Therefore, under the above conditions, the amplifier and "mike" will be functioning as they should.

The best quality will be obtained when the orator is talking through the "mike" and at a distance of no less than 8 in. Of course there are no hard and fast rules as the voices of different people can either make or break a successful speech reinforcement job, but in no case should the speaker be allowed to shout directly into the "mike" in order to make himself heard as this not only defeats the whole purpose of the public address system, but the quality will invariably be extremely poor.

With the elimination of the overloaded microphone condition, the second great trouble is improper impedance matching be-

tween component parts. As the sound, which is changed to electrical energy, is passed through transformers, attenuators and associated tubes until it finally reaches the sound projectors, its wave form is exceedingly easy to distort. It is, in fact, most miraculous that after what is done to the applied input, one gets even a semblance of it at the output. However, we usually assume that cheap transformers will give us poor quality and that the same applies to cheap microphones, sound projectors and tubes. Therefore, with this thought in mind, we purchase excellent transformers, microphones, sound projectors, and tubes, but when we decide on volume controls we undoubtedly look for the cheapest and simplest kind of a potentiometer without considering the only natural result from the use of a potentiometer across the winding of a transformer.

In Fig. 1 is shown the output of a transformer tied into the input of another circuit. The output level is varied by means of a potentiometer. As the slider is moved downward, the value of the resistance in parallel with the primary of transformer T1 is decreased until at point X there is a complete short circuit across the primary of transformer T1. This transformer may have excellent characteristics and may have been designed to match perfectly, the impedance of the circuits into which it is working, but after we get through changing its impedance with the potentiometer, there is little left of what was considered good, for with every variation of the potentiometer we change the impedance.

Constant-Impedance Attenuators

A transformer will work efficiently only when its primary and secondary impedances are matched to the lines from which they are worked or being worked. The only conclusion is, therefore, that the attenuators must retain and not change the impedance balance on lines between which they are interposed. For this purpose, special circuits were arranged to keep the impedance constant regardless of how the attenuators are varied. Such devices are known as "constant-impedance attenuators," or "C.I. pads."

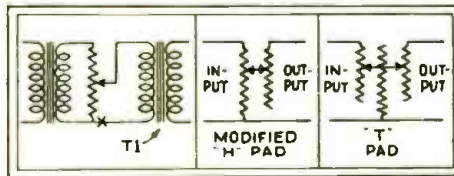
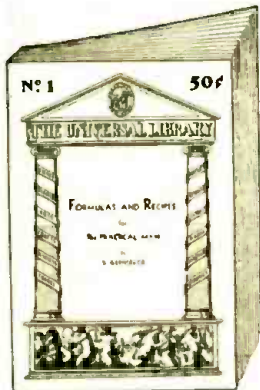

Fig. 1, left. Potentiometer volume control.

Fig. 2, center. Modified "H" pad.

Fig. 3, right. Constant impedance "T" pad.



FORMULAS AND RECIPES For the PRACTICAL MAN

CONTENTS

1. Adhesives, Glues, Cements, Gums, Mucilages, Lubricants
2. Cleaning: Stain Removers, Bleaches, Cleaning Fluids
3. Metal Craft: Coloring, Oxidizing, Plating, Repairing, Welding, Patinas, Alloys, Solders
4. Paints: Colors, Stains, Varnishes, Enamels, Lustrous Paint, Washable Paint, Paint-Removing, Waterproofing, Fireproofing
5. Glass-Working: Cutting, Drilling, Boring, Bending, Blowing, Etching, Engraving, Frosting, Silvering, etc.
6. Wood-Craft: Fillers, Fireproofing, Anti-rotting, Varnishes
7. Inks: Eradicators, Ink Stain Removers; Sympathetic, Invisible, Hectographic
8. Photography: Developers, Emulsions, Fixers, Sensitizing, Toning, Printing, Photographic Paper, Blueprint Paper
9. Antidotes for Poisons, Remedies for Burns and Scalds, Disinfectants, First-Aid in Accidents, Home Remedies
10. Preparation, Manipulation, Handling, Mixing, Emulsifying; Use of Hydrometer; Tables of Weights and Measures, Decimal System, Useful Tables.

THREE NEW 50c BOOKS

FROM the table of contents, it will be seen that the book contains only such material as is constantly needed and can be practically applied by the man who is doing or making things.

Every formula has been selected with a view to its usefulness to the experimenter and practical technical man.

Not only that.—This book is intended to serve directly for the use of the man who wishes to work out desirable preparations for practical home manufacture, as a means to earning spare-time money.

It is well known, in the case of innumerable preparations that have become household standbys, and whose production now runs into millions of dollars of profit—and if the truth were known, this would be found to be the origin of nearly all such successful enterprises—that the biggest manufacturers, who have built up tremendous factories making all these things which you use in your own home, shop, and business, started on the road to success with just such a small beginning as you, perhaps have been dreaming about.

This book will be useful also in helping you to save money by showing you how to make in your own home at a fraction of their usual cost the hundred and one preparations which you now buy ready-made for use in your home or business.

This book has been compiled by S. Gernsback, a well-known author of practical instructional manuals in various scientific fields. You will find it a real help and an instrument for self-advancement. It will serve you as a money-saver and a money-maker!

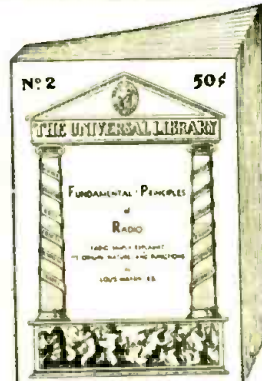

FUNDAMENTAL PRINCIPLES OF RADIO Radio Simply Explained—Its Origin, Nature and Functions

CONTENTS

- Chapter I—Fundamentals of Radio: Electricity, Resistance, Batteries, The Magnetic Field, The Magnetic Field, Inductance, Condensers, A.C. Circuits, Propagation of Radio Waves; Chapter II—The Simple Radio Set, Single, Two, and Three Element Sets, The Battery Set, Vacuum Tubes, Electric Sets, Loud Speakers; Chapter III—Diagrams, How to Read Them; Chapter IV—Amateur and Broadcast Stations, Talking Pictures, Television.

THIS BOOK is intended as a handy fundamental aid for "checking up" and systematizing your knowledge of radio, no matter what stage of the art you have thus far mastered by study or experience.

It is intended for those who may have had to get their first working knowledge of radio through experience in a haphazard fashion and now want to get a more solid grounding in its principles and theory.

It is intended for the practical man, the technician who wants to get a practical comprehensive knowledge of the principles underlying the HOW and WHY of Radio.

The book has been prepared with special consideration for the young members of the profession; and one of the main objects has been to state in plain English the few important elementary principles which the authors of most books on radio envelop in such a haze of technical mystery as to keep their explanations beyond the understanding of the ordinary man.

There is no more mystery about radio in the mind of the reader after he has read this book!

The author, being a former instructor in radio, knows how to go about explaining in simple language, the origin and nature of radio; he leads his reader through clear description and practical analogies, step by step, until he understands the working of the most complicated circuit.

You will find in Mr. Martin's book a really intelligible discussion of a lot of subjects in radio, for which you have never before been able to find an elementary explanation in such easy-to-grasp and understandable terms.

Even if you think that you know a very great deal about radio, you should get this book, even if only to see in what a charmingly easy way Mr. Martin has dealt with a difficult and abstract subject.

THIS MANUAL has been written especially for the man who wishes to acquire a working knowledge of the elementary principles of mathematics for his own every-day use. To provide a complete treatment, the author starts from the beginning of the subject, explaining the first principles of arithmetic in simple, clearly understandable language, and from these, takes the reader by easy steps through all the rules and processes of arithmetic calculation.

A good technician is not always a good mathematician, but the art of computation by figures is easy to acquire. If you are guided by some one who knows how to direct your way and make it easy.

That is the object of this book. Mr. Shalmark, who is an instructor in practical sciences, knows how to explain things in plain English, and his one purpose in this book is to make clear, in terms of daily application, the important basic principles of mathematics which everyone ought to know, whether he be a working man, a merchant, or a professional man.

Special attention is devoted in this book in showing the man who is employed in industry or in technical work, how to apply the working rules of mathematics in his profession or business.

All our books are of uniform size 8x9 in., containing 64 pages printed on strong paper with stiff colored covers.



ELEMENTARY MATHEMATICS For the Technician and Craftsman

CONTENTS

- I—Arithmetic: Addition, Multiplication, Subtraction, Division, How to Use Decimals; II—Fractions, Percentages, Ratio and Proportions; III—Powers and Roots; IV—The Metric System; V—How to Measure Surfaces and Volumes; VI—Mathematics for the Manual and Technical Craftsman; VII—Special Mathematics for the Radio Technician; VIII—Commercial Calculations, Short-cut Arithmetic, Interest Calculation, Discounts; IX—Weights and Measures; X—Useful Tables.

PRESS GUILD INC., 16 Murray St., New York City, RC-2

Enclosed find \$..... for which mail me postpaid the following books:

No. 1 }
No. 2 } 50c each, Postpaid, all three for \$1.25.
No. 3 }

Name

Address

City and State

The Bell Telephone Laboratories have used C.I. pads for a long period of time, and in the past it was only through this company and at great cost that they could be obtained. With the advent of commercial broadcasting the demand became severe with the result that the engineers of the Clarostat Mfg. Co. spent considerable time developing C.I. pads that could be marketed at reasonable prices.

In general, the two most common types of pads in use are known as the modified "H" and the "T." These are shown in Figs. 2 and 3, respectively. If the circuits are followed out, it will be found that regardless of the position of the movable section, both input and output values of resistance remain constant.

If now we build an amplifier which will supply our load, it is only necessary to have the proper mixing equipment for mixing the inputs into the system.

Mixing Equipment

Usually on a public address job there will be records to be played, speeches to be reinforced, possibly solos to be rendered over the system and local announcements made. Thus it is necessary to have an arrangement whereby one, two or three "mikes" can be handled.

Possibly, there also might be a large orchestra or band that will have to be picked up and transmitted to another location. Though a majority of the leading broadcasting companies find that the best microphone set-up, that approximates most closely the hearing of a normal person, is obtained through the use of only one microphone position, nevertheless it is well to plan a system so that more than one microphone position can be used when needed. The idea being to place two or three microphones throughout the orchestra and adjust the level of each separately until the best sound balance is obtained. Then the entire level can be either raised or lowered as desired by a master output attenuator. In this way, it is possible to make any instrument or group of instruments predominate over the others.

Going further into the design of the mixer, it would be fitting to list the features of our mixer:

1. Constant impedance always, with no loss or distortion of the applied input.
2. Carbon hiss eliminated to a marked degree by use of large bypass condensers.

3. All microphone button currents read by means of push buttons.

4. Only one meter used for all readings.

5. Individual on and off switches for each "mike," with a master switch for the entire mixer.

6. Internal amplifier.

7. All batteries contained in same box.

With the above factors in mind, refer to Fig. 4 wherein is illustrated a simple mixing circuit. However, it will be seen that using an arrangement of this kind does not give constant impedance control. Therefore, let us refer to Fig. 5. Here is a parallel arrangement of constant impedance attenuators feeding a common source in the input transformer to the amplifier. This method can be used but will not give as good results as that shown in Fig. 6 which is the circuit used in our mixer. In Fig. 7 is shown the complete circuit, and in Figs. A and B, panel and inside views of the mixer.

Since the mixer is to be used primarily for public address work, a volume indicator is not essential and therefore has been omitted. However, provision has been made for the use of such a device and the VI meter can readily be mounted in the upper left hand corner of the mixer panel with either a copper-oxide rectifier or vacuum tube arrangement fastened directly below on the inside of the panel.

It is possible to still further reduce the cost and at the same time incorporate the features as outlined before, by using a little different arrangement in that the mixing transformers may be replaced with resistors. The gain will be approximately the same as with transformers for the latter have a ratio of one to one. The schematic circuit is shown in Fig. 8. The condensers are used to isolate the direct current in each microphone circuit from the others. This layout is particularly interesting where space is of vital concern.

A word concerning the handling of carbon microphones. This type of instrument is very fragile; therefore, when using, extreme care must be exercised. Through some mistaken conception of the proper method of balancing button-currents, many radio men actually tap the unbalanced "mike" so hard as to cause the carbon granules to sift out onto the outside surface of the "mike" diaphragm. As soon as this occurs, the "mike" is ruined. It is a much better plan to regain balance by gently tipping and shaking

**SAY FELLOWS
GET INTO
ELECTRICITY**



Let me tell you how I can quickly train you, NOT by book study BUT by actual shop training on real electrical machinery in 12-WEEKS IN THE GREAT SHOPS OF COYNE IN CHICAGO

Electricity backed by training offers you many opportunities to get into jobs leading to \$50 a week and up. As I train you here at Coyne, you don't need advanced education or experience.

Earn while you learn. Lifetime employment service after you graduate.

It's a shame for you to go thru life as an untrained man and have to work for any old salary they want to pay you, when 90 DAYS here at Coyne will make you a trained man.

GET THE FACTS
mail the coupon today and I'll send you my big free book that tells you the whole story. It tells you how you can be a success just as hundreds of my graduates are.

Mr. H. C. LEWIS, Pres.
COYNE ELECTRICAL SCHOOL
500 S. Paulina St., Dept. 22-81, Chicago, Ill.

Dear Mr. Lewis: Send me your big free catalog and tell me all about the Free Electric Refrigeration course you are including.

Name.....
Address.....
City.....State.....

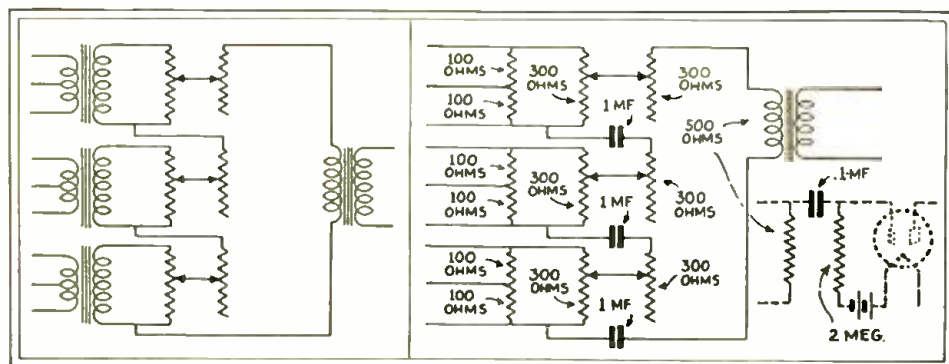

Fig. 6, left. The method used at the New Yorker for mixing the output of three microphones.

Fig. 8, right. The transformers used in the mixer of Fig. 6 may be replaced by resistors and condensers as shown above. This is especially desirable where space is at a premium.

-RELIABLE JR.-

1932 RADIO WITH ALL NEW FEATURES 5-TUBE MULTI-MU PENTODE

Using the new Multi-Mu tubes in conjunction with the Pentode for the utmost in selectivity, quality and sensitivity. **NO AERIAL NEEDED**—Built-in aerial eliminates the need of any antenna. Only a ground connection needed. Set up anywhere in a few minutes. **ROLA DYNAMIC**—A Pentode Rola Dynamic in conjunction with a high quality amplifier gives tone comparable to any receiver. **FULL VISION TUNING**—A full vision dial definitely marks the Reliable, a 1932 receiver. Selectivity and quality of the highest degree. Perfect tone quality and selectivity ample for the most congested sections.



\$16.75

Complete with R.C.A. Licensed Tubes

MULTI-MU

**P
E
N
T
O
D
E**



You cannot afford to be without a copy of our new 64-page catalog. Over 2,000 items of interest listed. A postcard brings your copy to you.

RADIO SURPLUS CORP., 56 R. Vesey St., N. Y. C.

SERVICE MEN! IMPROVE YOUR BUSINESS

By Keeping Your Name Before Your Customers Every Day

FRONT

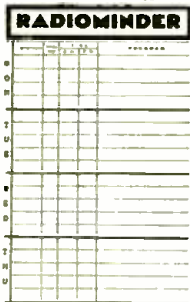

Most people tonight the day, the station, the dial number and hour of their favorite programs and will appreciate Radiominder Cards with spaces to record such information. They will be kept for the longest time in any home. Give Radiominder Cards with your ad printed on to your customers or place a few in every home in your neighborhood and they will constantly remind the people of you and thus think and talk about you.

There's No Better Way To Make People Think of You Every Day

These cards are far superior to business cards and their cost insignificant considering the benefits you will derive. Trial orders accepted for as little as

100 Radiominders with your Ad of 5 Lines Printed for **\$1.25** Each additional 100 Cards 50c Postpaid

Card size 3 1/2 x 5 1/2 inches. Ad-space 1 x 3 inches. Printed attractively on heavy Golden Rod Bristol Card. Use ink and handprint your copy and mail today with remittance to Dept. D—ROTH PRESS, 846 Sutter Ave., Brooklyn, N. Y.

BACK

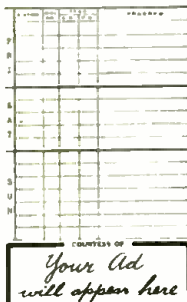

it. Should this not restore it to normalcy, then a pencil with an eraser on its end can be used to gently tap the circular frame of the "mike," being sure to use only the eraser part of the pencil. If it does not respond easily, then the chances are that the "mike" is packed. In any case do not handle or tap the "mike" with the current on.

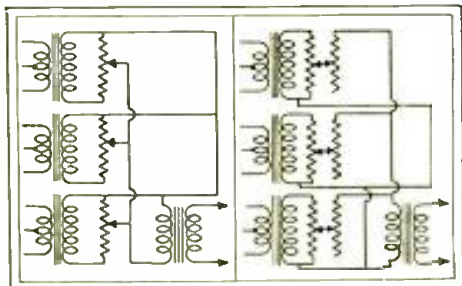

Fig. 4, left. Parallel connection of potentiometer-type volume controls.

Fig. 5, right. Parallel connection of modified "H" type volume controls.

Button current is a subject of considerable controversy as different microphone manufacturers specify different amounts of current. However, Western Electric (type 387) "mikes" generally can be relied upon to give excellent results in service and performance when operating at 15 milliamperes per button. It is unwise to use much more as the possibilities of packing the "mike" are greatly enhanced as the current is in-

creased beyond this figure.

In regard to the operation of the mixer, the button marked "A Volts" is pressed when reading either filament voltage or the "A" voltage at the battery. To read the latter, it is only necessary to throw the filament switch off and advance the filament rheostat to its full or maximum on position. The plate voltage is read on the opposite side by pressing the button marked "B Volts." To read "mike" current, it is only necessary to push the buttons corresponding to the microphone position and read directly in milliamperes. The total "mike" current through any one "mike" is obtained by pushing both current buttons for that "mike." In practice, the master current switch is turned on with the filament switch. The filament rheostat is then adjusted until the voltage as read on the meter is exactly 2 volts. Button currents on each "mike" are then read and adjustments made until each button has approximately 15 milliamperes flowing through it. The readings on each "mike" should be adjusted so that differences between the button currents on any one "mike" are no greater than about 5 to 8 milliamperes. Each "mike" has its own attenuator and current switch so that it may be thrown completely in or out of the circuit or have its energy output raised or lowered without in the least way affecting the operation of the rest of the mixer.

(Continued on page 506)

Short-Checkers

(Continued from page 475)

It is considered best, however, to use a series condenser as then there is no glow, except for the first few cycles of A.C. supply after the tube is placed in the socket. This shows as a brief flash of the neon lamp as the condenser charges and, if the condenser is high grade and does not leak, no more current is allowed to flow. This is especially convenient in checking cathode to heater leakage because if the neon lamp were allowed to glow on one electrode, this leakage would be "washed out," or obscured, as it were. Some care is necessary in deciding when a cathode to heater leakage is excessive. In the writer's experience, some makes of tubes are much worse than others in this respect. It may be of assistance to know that the type of neon lamp specified will glow at full brilliancy with approximately five milliamperes of current flowing and if the neon lamp should glow with more than a very slight or faint degree of brilliancy, the tube should be considered as either "leaky" or "gassy" and if the neon lamp glows with anything approaching full brilliancy, the tube should be considered shorted.

Reference has been made, in the discussion of Figs. 1 and 2, to the specified type of neon lamp and to the series condenser, and if the tube is tested "hot" using A.C. supply, the same rules apply as above. It is a good idea, in using any short-checking device, to tap the tube several times during the process of checking in order to better detect intermittent shorts.

As stated before, the circuit of Fig. 2 can be adapted to either 110 volts A.C. or D.C. If using A.C., use the type of neon lamp specified above, but if using D.C., it will be necessary to use a type of neon lamp responsive to D.C., such as G10-1 watt for A.C. or D.C. and in this case, as mentioned before in discussing Fig. 2, it is best to check the tube "cold."

A peculiarity of the neon circuits shown in Figs. 4 and 5 should be mentioned. In switching the test circuits from one set of connections to another with filament or heater "hot," a brief flash of the neon lamp may take place, but this should be disregarded as it is caused only by disconnecting a tube element from a portion of the circuit which is at one potential and connecting it to a portion of the circuit at a different potential with respect to the previous one.

"LET THERE BE LIGHT—"

ACCORDING to a recent newspaper dispatch from London, the London Radio Show boasted of a light-equipped radio map of Europe. It is so designed that when a certain station's broadcast program is being received by a radio set, a light shows on the map at a point indicated for that particular station. Every station in Europe is said to be represented on this map.

We have a suspicion that the urge to tune in stations and thus make lights pop up all over the map of Europe would be greater than a desire to listen long to one program.

How to "Sinc" Disc and Film

(Continued from page 468)

ratio of 16 frames of film to one record revolution. This has since been adhered to as the "home" standard for high-speed records.

It so happens that the projector best adapted for home use is one which uses a 12-frame sprocket, so that in order to maintain the prescribed speed ratio, the mechanical ratio must become two to three instead of two to one.

Starting with the record, we find that if we run the film at the standard of 24 frames per second, that the record is running at 90 revolutions per minute. This is too fast, so we have an odd standard to follow.

It is best to maintain the record speed, as the film speed will still be fast enough for all practical purposes. Experiments in recording have shown that the slightest non-uniformity of motion will cause wavers and chatters in the sound. We may start then with the assumption that the turntable of any recorder must run at constant speed. In fact, this must be the case with any recorder if success is to be expected. Anyone who has experimented with home recording will have found this to be true.

If a recorder of the usual type is available, the substitution of a more powerful motor will enable you to connect it to the projector with a flexible cable. This being a physical connection, synchronism is positive. This is somewhat inconvenient at times as the projector must be disconnected from its own driving motor. This necessitates constant changing if the projector is to be used for both silent and sound projection. For this reason, most experimenters prefer to maintain independent synchronism by means of stroboscopes.

Theory of Stroboscopes

It follows that any speed variation which occurs in maintaining synchronism must be on the part of the projector where it will be hardly noticeable.

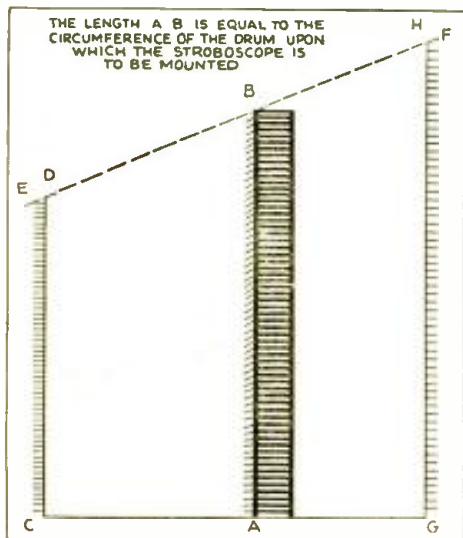

Fig. 1

The length AB is equal to the circumference of the finished strobe; CE and GF have the same number of divisions.

Stroboscopes are widely used in professional recording and are of great value in uniform speed of any rotating member of a mechanism.

Most of the electric current supplied for household use in this country is of the alternating variety. It may alternate 25, 50, or 60 times per second. If you do not know the frequency of the current which you use, an inquiry addressed to your electric company's office will secure the information for you.



Fig. C

Laying out the projector strobe.

As a cycle is a complete wave with maximum upon both sides of the zero line, any incandescent lights supplied from such a source will brighten and dim twice as many times in a second as the frequency. Thus if the frequency is 25 cycles, there will be 50 brightenings and 50 dimmings of the light each second. For 60 cycles, the most common frequency, there are 120 bright periods each second. In each minute there are 7200 flashes.

Now suppose that we have a wheel which is turning 7200 times each minute. If half of this wheel is black and half is white it will appear to stand still if the light from an incandescent lamp falls upon it because we only see the wheel lighted when the white portion is in one spot, say the upper side. When the white side of the wheel is uppermost the light is bright and we see it, but when it is the black side which is uppermost we don't see it because the light is dimmed. As long as the speed of the wheel and the frequency of alternation are the same the wheel seems to stand still.

It follows then that if we make a disc of cardboard and draw lines upon it in such a position that each succeeding line will be in the exact place occupied by the preceding one at the instant of the bright flash, we can make the lines appear to stand still. Since any one line pattern will stand still at just one speed, an effective speed indicator is found in such a device. Moreover, if the speed is slightly faster than it should be the lines will revolve forward slowly, and vice versa. Thus by the direction and speed of the apparent motion of the lines we have an indication of whether the speed is high or low and to what extent.

The Turntable Strobe

The first thing to do then is to make such a device which will indicate the proper speed



Readrite

No. 550

OSCILLATOR

(Licensed by A. T. & T. Co.)

\$18

Net to dealer
\$30 list

\$21

Net to dealer with
output meter

If not at your Jobbers, we will ship direct when remittance accompanies order.

A sturdy modulated instrument carefully made. Completely shielded with separate battery compartment. Furnished with 22½-v. and 3-v. batteries. Also one '30 tube. Direct reading broadcast band (550-1500-k.c.) and intermediate band (120-185 k.c.). Sharp 2d and 3d harmonics for 260-475 k.c. Operating instructions attached in case cover with shielded wire leads. Very compact. In leatherette case, 6 x 11½ x 5½ in. Weighs but 8 pounds. Built to high standards.

Every serviceman should have the No. 550 oscillator to align r.f. gang condensers, locate defective r.f. transformers, adjust i.f. transformers, check oscillator stage and determine sensitivity of a receiver. A necessary instrument. Get yours today. Write for catalog of servicing instruments.

Readrite Meter Works

Established 1904

17 College Ave., Bluffton, Ohio

Classified Advertisements

Advertisements in this section are inserted at the cost of ten cents per word for each insertion—name, initial and address each count as one word. Cash should accompany all classified advertisements unless placed by a recognized advertising agency. No less than ten words are accepted. Advertising for the March 1932 issue should be received not later than January 7th.

BUSINESS OPPORTUNITIES

RADIO EXPERIMENTERS: You can easily add to your present income by Locating Buried Treasures and Underground Metals through Radio Methods. We teach you how to build and operate. Full details for Red Stamp. Exchange, Box 607, El Monte, California.

CHEMISTRY

BECOME TRAINED CHEMIST. Thousands of opportunities—fascinating career. Learn at home. Complete experimental laboratory outfit given. Write for big free book. Chemical Institute, 19 Park Place, Dept. RC, New York.

INVENTORS

PATENT YOUR INVENTION: Send for FREE book, "How to Obtain a Patent," and "Record of Invention" blank. Consult us about how to protect your ideas. Victor J. Evans & Co., 620B Victor Bldg., Washington, D. C.

LATHES

AN 8-INCH Back Geared Screw Cutting Lathe for Radio Shop and Experimental Work. \$100 up. Easy Payment Terms. Cuts screw threads and machines metals of all kinds. Write for Circular No. 8 with illustrations, prices, and terms. South Bend Lathe Works, 150 Madison Street, South Bend, Ind.

RADIO

TRANSFORMERS (Radio Power) rewind, special types made to order. Supreme Radio Laboratory, 16 Fulton Avenue, Rochester, N. Y.

REACTIVATE AC Tubes, battery charger bulbs. Repair audio transformers, loud speakers, phones and other radio apparatus without rewinding. Diagrams and instructions, \$3.00. Kit prices furnished on request. GNS Radio Laboratory, P. O. Box 203, Bath, New York.

SET OWNERS, separate those interfering stations on your tuning dial. Easy to install. 50c postpaid. Noel, 1502 Pittston, Scranton, Penna.

SONG POEM WRITERS

SONGWRITERS! Poems, melodies. Outstanding proposition. Hibbeler, D153X, 2104 Keystone, Chicago.

BACK ISSUES of RADIO-CRAFT

can still be had at the regular price of 25c per copy. If you are in need of any issues to complete your file, send us your remittance in check, stamps or money order, together with the months and year, and we shall forward your copies to you immediately.

RADIO-CRAFT

98 Park Place New York, N. Y.

of the record. To do this, draw a circle upon a sheet of paper and with a protractor lay off the circumference into 90 segments of four degrees each as shown in Fig. A. When this is done, draw a heavy ink line along the side of each segment which is half as wide as the segment itself. When this is done, you should have the circle divided into 90 black lines spaced by 90 white lines of equal width. Place this card upon the turntable, a hole having been punched in its center to pass over the post of the turntable. This is indicated in Fig. B. Adjust the speed of the table until gray lines are seen to stand still upon the surface of the card. When this is done the table is turning at 80 revolutions per second.

How is it possible to know this? There are 7200 light alternations per minute. The table is to turn 80 revolutions per minute. Divide 7200 by 80 and the result is 90, the required number of segments. Remember for each black segment there must be a dividing white one.

Take the reading while cutting a record as the table usually moves more slowly when cutting a record than at other times.

The Projector Stroboscope

And now for the projector. The projector sprocket revolves three times while the turntable revolves twice. Therefore, the sprocket makes 120 revolutions per minute. If we divide 7200 by 120, the result is 60. Therefore, for the projector we must have a stroboscope of 60 black lines.

However, because the sprocket shaft is revolving directly in front of us, we must alter the shape of the stroboscope or we would be looking directly at the edge of it.

The cover of a round cardboard carton serves as the foundation for this stroboscope. The first step is to find the exact center. Around this we draw a circle whose diameter is the same as that of the round thumb nut upon the left end of the projector shaft. After the circle is drawn it is divided equally by four diameters, pie fashion. A sharp knife is used to cut these diameters and the pointed flaps pushed inward as shown in Fig. C. If the lid is now pushed upon the projector nut the tabs will hold it securely in place. Run the projector to see that the cover revolves truly upon the shaft.

With a flexible tape, or a piece of paper, measure the exact circumference of this carton lid. This is the length of the stroboscope belt, which must be exact. Let us say that this length is $6\frac{7}{16}$ ins. How are you going to divide this into 60 exactly similar bands?

In the center of a piece of paper, draw a line of just this exact length. Parallel to it and at the top of the paper draw another line. Divide the upper line into sixty equal parts. By using an engineer's scale of 144 parts to the foot, the upper line will be just five inches long. Draw a line from the end of the upper line and touching the end of the center line, and extending obliquely downward. Now select a larger unit, such as the 96 to the foot and find a point where 60 of these divisions exactly fill the distance from the left of the paper to the oblique line. Draw a third line and divide the lower line into 60 equal divisions.

You now have three lines, the upper one shorter than the center one and the lower one longer. Both upper and lower are divided into sixty equal parts, and the ends of all three may be joined by a straight line. Now draw lines between the corresponding divisions of the upper and lower lines. Where these lines cut the central line will divide it into sixty equal divisions. In this way a line of any odd length may be divided into any desired number of equal divisions. Fig. 1 shows this method of making a sixty division stroboscope.

When the line has been divided, draw a line parallel to it and about a half-inch distant. Between these draw the sixty divisions by drawing parallel lines at each marked division. Finally, use a broad pen and fill half of each segment with ink. The result will appear like the accompanying drawing. Cut out the stroboscope belt and discard the rest of the paper.

Lay the carton lid upon the table and paste the belt around its edge as depicted in Fig. D. If the work has been carefully done, the belt will just fit and the joint come exactly between the white and black end segments. Place the drum stroboscope which you have just completed upon the projector and you have a speed indicator of the utmost delicacy, shown in Fig. D.

Adjusting the Speed

As the speed control of most amateur projectors is merely a rheostat of the wire-wound variety, it is advisable to substitute a more sensitive carbon rheostat of the table-mount type. This gives you a smoother and more delicate control of the speed.

Now thread the projector with film and see if you can hold it to a speed where the stroboscope lines remain fairly steady.

So delicate is the indication that the lines will be seen to swing forward slowly, then backward and so forth, but no control is exerted until the lines are seen to sweep forward or backward continuously. Even then, after waiting for this definite movement there will still be time to correct it before an error of more than two or three frames has been accumulated. Upon the reverse, or correction, this error will be compensated.

STATISTICS

RECENT U. S. census figures indicate that there are approximately 14 million radio sets in operation in the United States; and that nearly one-half the population of the country, or 50 million people, can be classed as "listening public."

The figures which concern a large city are of particular interest. New York City, for instance, boasts that of its 1.7 million families, approximately 1 million are radio set owners; 70% of these sets are electrically operated. Incidentally, of the 3.1 million families in New York State, 1.8 million have radio sets. It is interesting to note that city and state figures closely agree as to the proportion of "listening public," with city interest in radio taking a bit the edge over that of the rural-ites.

It is estimated that in New York, Pennsylvania and Illinois are to be found one-fourth of all the radio sets in the country; and more than one-third of the listening public.

CRAFTSMAN'S PAGE

(Continued from page 469)

The significance of this is that we can have a perfect acoustic response up to any frequency limit, say 5,000 cycles, and then choose a value just slightly higher than this, say 5½ or 6 kc., as the frequency separation of stations. This has, so far, been considered an impossibility, and, in fact, it has been considered that for a 5-ke. acoustic response, it is necessary to separate stations by 10 kc. We have thus introduced the conditions which allow for more stations being employed simultaneously without mutual interference.

2. *Frequency Modulation of the Stenode.* Mr. Fitch raises the question as to whether a "Stenode" would operate for a purely frequency-modulated station. I am glad he has brought this forward, for it gives me an opportunity to refer to the processes by which I arrived at the "Stenode."

I saw, with apprehension, the approaching saturation of the ether, and set myself the problem of trying to avoid such a catastrophe. My first idea was to employ a frequency modulator device wherein the maximum frequency modulation would not exceed 10 or 20 cycles. It was easy to visualize the transmission apparatus for this purpose but not so easy to conceive a method of reception which would show a change of response for a few cycles of change of fre-

quency. Former work which I had done with Cady's Quartz Resonators came to my assistance, and I determined to investigate the possibilities of using quartz crystals for such reception. I was immediately faced with an apparent stumbling block, that the enormous selectivity of a quartz crystal would cut off all the side bands, and there was no doubt that frequency-modulated waves had side bands as well as amplitude-modulated waves. I refused to let this stop me, and owing to the connection between telegraphic signals and telephone modulations, I really began to study modulation problems from first principles, resulting in the discovery of at least two methods of using quartz crystals for receiving modulated waves—one of them being now well known as the "Stenode." Having started out to search for a receiver for frequency-modulated waves, I soon appreciated that my results would apply just as well to the ordinary amplitude-modulated waves, and thus for the time I left frequency modulation alone, although there is no doubt that still further new results await us when this subject is fully investigated. At the time of my first public announcement of the "Stenode," I had these possibilities very well in mind.

JAMES ROBINSON.

OPERATING NOTES

(Continued from page 477)

motor commutator with very fine sandpaper. These observations are the result of actual service and no trouble has been mentioned that has been found to happen only once.

Replacement procedure and explanation has not been attempted, for every Service Man can secure a copy of a manual describing fully the parts and operation and replacement of the mechanism.

Sonora Model "A44"

Recently, a Sonora model "A44," the schematic diagram of which appears in Fig. 1, caused a bit of annoyance. Upon the first service call, all the '27 tubes were found weak. The set appeared in all other respects to be in good order. A new set of tubes was placed into the set and it functioned as well as ever. About two weeks later, the same complaint of weak reception was received. Another call disclosed all the '27 tubes weak. The second Service Man did not know of the first report and suggested replacement of all the '27 tubes. This set uses six of these tubes. Upon being informed that the tubes were purchased only two weeks previously, a check was made on the receiver.

The filament voltage was correct but the voltage impressed upon the plate of the '27's was about 350 volts. No doubt, this excessive voltage paralyzed the tubes. Even the detector tube which had about 225 volts on the plate was very weak and barely drew any plate current. The Service Man immediately checked a schematic circuit of the receiver to ascertain which portion of the set would be most likely at fault.

A glance at a diagram will disclose a resistor which acts as a bleeder and cuts the high voltage down to 135 volts for the R.F. and A.F. amplifier '27 tubes. This resistor should have had a resistance of 14,500 ohms but upon test showed a resistance of 25,000 ohms. Replacement was made with a 50-watt 15,000-ohm unit and the proper voltage was obtained. The tubes were replaced for the customer without charge and the job was done.

Kolster Models "K20," "K21," "K22," "K24," etc.

In the repair of Kolster "K20," "K21," "K22," "K24," etc., receivers, it is most important that grid suppressors of the same size be substituted for those that have burnt out. Failure to do this, especially when the replacement is of a lower value than the original resistor, will throw the set out of balance. To eliminate oscillation, the size of the grid suppressors should be increased. Too great a value will impair the sensitivity of the receiver and should be guarded against. The location of the grid suppressors is shown in Fig. 2.

Fada Model "43"

On several Fada "43" receivers, the condition of undue oscillation and distortion was reported. Analyzer socket tests showed no abnormal condition, so a series of tests was carried on to determine in what part of the circuit lay the cause for this complaint. As the oscillation generally ran hand in hand with distortion in these sets, it was

(Continued on page 502)

You want to earn more money—You want to be sure of steady employment—You want to be certain of your future—Here then is the opportunity you have waited for.



GET STARTED NOW—LEARN

Here is a blazing message to real, red-blooded he-men.

Broadcasting stations use engineers, operators, and maintenance men, and pay \$40 to \$100 a week and up. Manufacturers, jobbers and dealers employ thousands of men as engineers, foremen, inspectors, testers, service men, salesmen and managers, and pay \$40 to \$150 and \$200 a week. Sound picture concerns and public address systems use engineers, installation and maintenance experts, etc. and pay \$40 to \$200 a week and up. Manufacturers of photo-electric cell equipment (Radio's electric eye) use designers, adaptation engineers, installation men and salesmen, at \$40 to \$200 a week and up. Steamship companies employ hundreds of Radio operators, give world-wide travel, at salaries of \$85 to \$200 a month and all expenses.

RADIO

TELEVISION
TALKING PICTURES
SOUND SYSTEM
PHOTO CELL WORK

AT HOME—and get into the world's fastest growing and best paying industry

Why then, should you slave away at \$20 or \$25 or \$30 a week, on a back-breaking no-future job, when Radio offers such wonderful opportunities for good pay and advancement?

Never before has such a chance been available to the average working man. It's an opportunity that is open to every normal, ambitious man—regardless of age, schooling or experience, who is willing to spend 30 minutes a day or more, for a few months, in learning the theory and practical application of all Radio devices.

You will be taught at home, under the actual supervision of a group of Radio executives and engineers, with a course of practical and up-to-date training, endorsed by sixteen of the largest and most progressive Radio manufacturers, among whom are—Brunswick, Crosley, Fada, Philco, Majestic, Stromberg-Carlson and Zenith.

Where only hundreds of men were employed in Radio a few years ago thousands are employed today. Where only a hundred jobs paid \$50 to \$75 a week a few years ago, there are thousands of such jobs today, and there will be thousands more for trained men in the next few years.

If you are interested in bettering your position—if you want to get out of a small-pay, no-future job, into good-pay, big-future work—all in the coupon below and mail it at once, as men are being enrolled for this training now. There will be no obligation. And it will certainly pay you to investigate.

FREE OPPORTUNITY BOOK COUPON

RADIO AND TELEVISION INSTITUTE,
Dept. 62, 2130 Lawrence Ave., Chicago.

..Please send me a copy of your Opportunity Book and full particulars of your plan for helping men into good pay positions in the Radio field.

Name

Address

City..... State.....

Free Every Manufacturer, Dealer, Distributor, Serviceman should have on file the

New, 1932 Edition of the

CLAROSTAT

CONTROL HANDBOOK and CATALOG

containing complete specifications on Clarostat Variable Resistors, Volume Controls, Tone Controls, and Voltage Controls together with complete information on their use in experimental, service and replacement work.

Write Dept. R.C. for Your Copy

CLAROSTAT MFG. CO., Inc.

285 N. 6th Street

Brooklyn, N. Y.

A SELF-POWERED S-W CONVERTER

(Continued from page 480)

The converter is housed in a wooden cabinet of the mantel-clock type. The outside dimensions of the cabinet are 10¾ ins. high, 8¾ ins. deep and 12¼ ins. long.

Operating the Converter

There are four controls on the panel. The main tuning dial is in the center, on the left is the modulator tuning knob for fine adjustments and on the right is the knob controlling the D.P.D.T. switch. The power-supply switch is located under the main tuning dial.

To operate the converter, the aerial is disconnected from the broadcast receiver and connected to the aerial post of the converter. The output terminal of the converter is then connected to the aerial post of the receiver and a connection is made from the ground terminal of the converter to the ground of the receiver. Both the converter and the receiver are turned on and the switch on the right hand side of the converter is turned clockwise to connect the converter into the circuit. The broadcast receiver is tuned to 1000 kc. and the volume control of the receiver turned up. The main dial of the converter is then tuned until a carrier is picked up and then the auxiliary knob on the left hand side of the panel is adjusted for greatest volume. The volume

control of the receiver is then used to level off the volume of the signal.

All values of parts used in the construction are marked on the diagram of connections. No difficulty should be experienced in making this converter function as the design has been reduced to the simplest form possible.

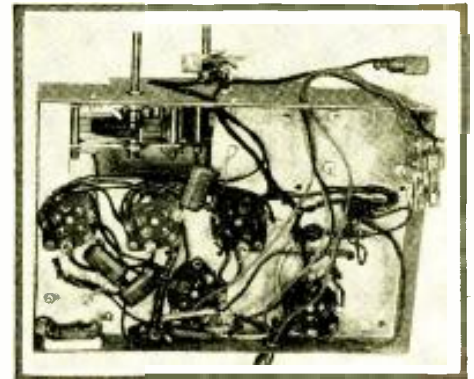
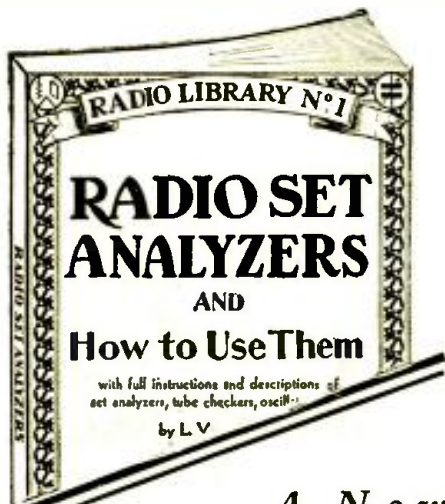

Fig. B

Under-view of the very compact converter.

This converter has been placed on the market by the Radio Service Laboratories Co.



A New and Useful Book for Service Men—

HERE is the latest book, and one of the most important which we have ever issued. It fills a long-recognized want for there is not a Service Man or a radio-trickian who has not an immediate use for this welcome book.

It is the first book that explains COMPLETELY the operation of analyzers, tube checkers, oscillators, etc., from a thoroughly practical standpoint. The book is intended for Service Men of all classes, whether Junior grade or expert. Everyone will find a tremendous amount of live "meat" in its pages. Nothing has been left to your own ingenuity; everything is complete.

CHAPTER 1: Introduction:

The Problems of the Service Man
General Description of Modern Receivers
The Need for a Radio Set Analyzer
What to Expect from an Analyzer

CHAPTER 2: The Analyzer:

The Fundamental Requirements of an Analyzer
The Switches or Push Buttons
The Ammeter
Multiscale Ammeters
The Shunt and Its Calibration
The D.C. Voltmeter
The Multiscale D.C. Voltmeter
The Multiplier and Its Calibration
The A.C. Voltmeter
The Design of a Simple Analyzer

CHAPTER 3: Trouble Shooting with the Analyzer:

Classification of Trouble—
(1) External to the receiver
(2) In the receiver proper
(a) Mechanical troubles
(b) Electrical troubles
Detailed Analysis of Electrical Troubles—
(1) Tube Testing
(2) Localizing trouble
(a) By past experience
(b) By actual test of circuit
(3) Interpretation of analyzer readings
(1) Tube charts (use of)
(5) Circuit diagrams (use of)
(6) Testing the power unit
(7) The use of the analyzer in testing individual units
Additional Features and Use of the Analyzer—
(1) As a modulated R.F. oscillator
(2) As a means of lining up R.F. and I.F. amplifiers
(3) As an output meter
Care and Maintenance of Analyzers
Conclusion and Brief Summary

CHAPTER 4

Detailed descriptions, photographs, and circuit diagrams of commercial set analyzers.

Published by RADIO-CRAFT it has included in it all worth-while information available to the radio servicing profession.

50c

We know that, if you are at all interested in radio service work, you will send at once for this valuable book.

The Copy

Mail Coupon Today!

GERNSBACK PUBLICATIONS, Inc., RC-232
96-98 Park Place, New York, N. Y.

I enclose herewith fifty (50c) cents, for which send me a copy of your book "Radio Set Analyzers and How to Use Them."

Name

Address

City and State

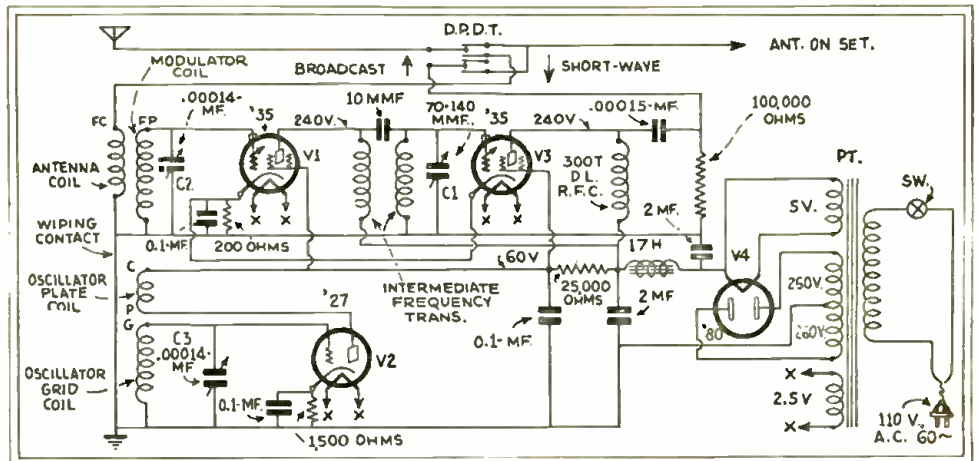

Fig. 1

Schematic diagram of the S-W converter. All the coils, for any one band, are wound on a single form, thus making wave-band changes an easy matter.

OPERATING NOTES

(Continued from page 501)

conceded that the reason for the former complaint was the same as for the latter. This is fairly obvious.

A magnetic pickup was coupled to the grid of the first audio 227 and record reproduction attempted, which proved to be free from any distortion. The same pickup was coupled to the detector 224 and again the amplifier used to reproduce the record. Here, however, noticeable distortion resulted. The detector circuit was checked and after close inspection, it was found

that the gray carbon resistor connected from screen to chassis was not 125,000 ohms as listed on the circuit schematic, shown in Fig. 3, but was close to ¼ meg. When substitution was made with the proper size, proper reception and reproduction was had.

Rather peculiar about the whole affair was that detector screen-voltage was not decreased any noticeable amount when the lower value resistor was put in. However, lack of the proper resistor resulted in general detector unbalance.

PUSH-PUSH RECEIVERS

(Continued from page 470)

34 ma. for the "B" supply. We can therefore see that whereas we can obtain quite a kick from the two '33 pentodes in push-pull, the plate current and filament drain make them impractical for use.

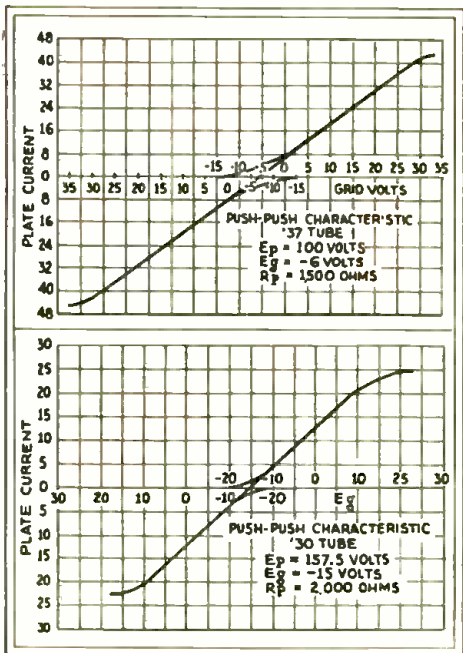

Fig. 1, above. Characteristics of the '37.

Fig. 3, below. The '30 tube's characteristics.

In Fig. 3, we have the curves for the '30 tubes in the push-push arrangement—where it can be clearly seen that the power output available from these tiny general purpose tubes is 1000 milliwatts when operated in this connection. Furthermore, it should be noted that the average plate current drawn will be of the order of 14 ma. for the two tubes, but because of the fact that the signal is not always at its peak power the current drain during operation will not ex-

ceed an average of 7 or 8 milliamperes for the two tubes. This is not only easy on the "B" batteries but we have achieved our power output with the small tube of the line which permits our drawing but .36-amp. for the six-tube receiver, shown in Fig. 4. This is well within the limits of the air-cell battery. The plate voltage demands total 157.5 volts and a negative biasing potential of 15 volts.

Here again it is not necessary for us to employ a special transformer in order to improve the possibilities; for a transformer devised for operation with the '45 tube will "stand the gaff." In view of the much higher efficiency obtainable where truly efficient matching is available, it is to be hoped that manufacturers will shortly supply input and output transformers truly suited to the requirements of the push-push amplifier.

In closing, one comment seems in order as many have asked why greater power output could not be obtained with the '45-'47-'71A, etc., if used in the push-push connection. The difficulty lies in the fact that these tubes do not operate in a satisfactory manner in the positive grid range into which push-push operation swings the tubes.

The writer has some faith in the possibilities of the pentode when thus operated but as yet has not been able to evolve the special circuit arrangements necessary to undistorted operation of the pentode tubes in the push-push arrangement. He feels not overly optimistic in saying that within a short time the data on such operation will be forthcoming.

The present difficulty with the low-impedance power tubes—such as the '71A and the '45—lies in the fact that the grid current drawn is so great that unless the input transformer feeding the push-push stage is of exceedingly low ratio, the grid resistance will be reflected into the plate circuit of the preceding stage—playing "hob" with the quality.

RADIO-CRAFT KINKS A RESISTANCE CALCULATOR

(Continued from page 482)

To make a measurement, proceed as follows; referring again to Fig. 2, the unknown resistance is connected to the terminals at 3 and 4. There is no need for haste in taking the readings as the current used will have no effect whatever upon the voltage. Assuming that the resistance is not known, have the switch at the left open thus cutting the 2500-ohm resistance into the circuit. Move the arm P to the right as far as possible, thus decreasing the voltage to a minimum. Plug into the 110-volt lighting circuit. Next move the voltage adjustment to the left until the voltmeter indicates 10 volts. If the reading on the milliammeter is low, close the switch and forget about the 2500 ohms. The most accurate conclusions are arrived at when using that part of the curve between 2 and 5 ma. Therefore, should the meter show less than 2 ma., move the voltage up until it comes within these limits.

Assume that it requires a potential of, say, 10 volts to produce the desired current flow, and again for purpose of explanation, assume that this current is 3 ma. Following the vertical 3-ma. line to the point where it intersects the curve, and looking left along the horizontal line also intersected at this point, it is found that the resistance value lies between 3000 and 4000 ohms. And as each horizontal line represents 100 ohms, the exact value is 3330. This would be true if the voltage used was 10; however, as 10 volts were used simply multiply the result by 4, giving 13,320 ohms as the resistance.

In this manner, one curve is used for any multiple of 10 volts by simply multiplying the result by the multiple used. Using 50 volts, multiply by 5; or using 90 volts, multiply by 9. Any value can be measured with 10 volts between 1000 and 10,000 ohms and taken directly from the curve.



Won't I Ever Get Ahead in Radio?

Progress in radio is determined purely by knowledge. Even practical experience doesn't help if you haven't got a FULL KNOWLEDGE OF RADIO FUNDAMENTALS.

There's more to radio than just knowing HOW to repair or construct apparatus—you've got to know WHY it operates after you do.

To men who are striving toward a REAL FUTURE in Radio—whether as Service Men, Factory Engineers, Transmission Men, Operators or Broadcast Engineers—we offer an endorsed course of training that, by teaching BASIC RADIO ENGINEERING, makes you fit to hold these important jobs.

GET THE DETAILS

The coupon brings you interesting booklet and full particulars by return mail. No obligation. Mail it now—while you think of it.

CAPITOL RADIO ENGINEERING INSTITUTE, Inc.

14th St. and Park Rd., N. W., Dept. B-12, Washington, D. C.

Without obligation, please send me details about your home study training in Radio or Television.

Name

Address

Location..... State.....

Make a PROFIT

Service men make \$90 extra per month installing AMPERITE. Send \$1.62, to Dept. RC-2, for complete sample and sales helps.

AMPERITE Corporation
561 BROADWAY, NEW YORK

AMPERITE
Self-Adjusting
LINE VOLTAGE CONTROL

ALUMINUM BOX SHIELDS

Genuine "ALPOV" stock, silver-plate finish, 7 x 9 x 8, \$1.89—14 x 6 x 6, 3.85, 10 x 7 Monitor size \$3.25, 7 x 5 x 5 Coll Shield (like picture on right) \$1.00. Any Size to Order. 12 x 13, Alum., 60¢; Goose-neck tubing, 60¢; 3 point single pole switch, 15¢; 001 Bakelite Condenser, 12¢; 1 watt, 50,000 Variable, 85¢; R. C. choke, 3¢; Two Way Push Button, 25¢.

"BUDDY" TEST PRODS.

Always sharp pointed, using phonograph needles, 4-ft. wires, spade or phone lips. Colored nipples identify each lead, \$1.50 pair.

We specialize in radio parts exclusively—parts furnished for any kit in any magazine. Carrying cases for Set Testers, Analyzers, Portable Sets.

BLAN, THE RADIO MAN, Inc.
89 Cortlandt St. Dept. RC-232 New York, N. Y.

"CODE WIRING"

(Continued from page 473)

asks for a little clear thinking on the subject. Yet there is no doubt in the writers' minds that a few more fires caused by "hay-wire" radio installations and perhaps the life of a child or other person resulting, will cause some member of the legislative body of this city to introduce a law doing away with unlicensed electrical work.

Human nature being inclined to swing to extremes, it is possible that this bill will also do away with "junk-shop" radio sets, auction radio steres, the use of second-hand material of any kind, and other conditions that Cortlandt Street has called into being generally.

The Underwriters' Viewpoint

Mr. Corlies agrees with Mr. Whittaker and adds:

"The most casual inspection of the applications filled out by students enrolling for radio courses in the various schools show that few of these are from the electrical industry. Many are from classes of life where no tools of any kind have ever been used. How can we expect them to become expert mechanics after three months in night school?

"Radio courses are all right. The thing to bear in mind is that any course of schooling can, at best, only be a start in any career. Even a college graduate, after four years, must start at the bottom of his calling and learn to apply, in a practical manner, the knowledge he has gained in school. So should a radio man, finishing his course and embarking upon a field which is a branch of the electrical industry, learn the rules which the experiences of others before him have found necessary to follow.

"An electrician helper soon learns to respect amperes and the crupereature of the electric arc. Shocks from voltage on the 110-volt lines, which seem to be the great danger he is facing in the popular imagination, really mean very little to him. In a very short time, he is placing his fingers across the line to test for presence of voltage, rather than dig the test lamp out of the bag. But amperes overloading wires burn his fingers, melt his screw driver to slag in a short circuit, singe the hair off of his hand when he closes a large switch with his hand; and send him home with a bandage over his eyes for two weeks when he sees the flash of a 100-ampere fuse blowing out, as he grounds a live service leg.

"Thus the presence of a potential Mrs. O'Leary's cow in every pair of wires connected to the street service is early recognized by him and he will agree with the Underwriters in asking that all live wires be protected from mechanical or other injury.

"I wish to add a few words to Mr. Whittaker's statements about tacked cord about baseboards and up walls. Children at play, a dog nibbling, a cat sharpening her claws, a sharp-edged object falling across the wires, any other of dozens of causes may produce a flash that will ignite the insulation and start a fire. If this occurs while there is a person around with the wit to immediately

(Continued on page 506)

And NOW

THE greatest book of its kind ever published. **HOW TO BUILD AND OPERATE SHORT WAVE RECEIVERS** is the largest and most up-to-date book on the subject ever put between two covers.

The book has been edited and prepared by the editors of **SHORT WAVE CRAFT**, and contains a wealth of material on the building and operation, not only of typical short wave receivers, but short wave converters as well.

Dozens of short wave sets will be found in this book, which contains hundreds of illustrations; actual photographs of sets built, hook-ups and diagrams galore.

WE SAY—AND REPEAT IT—THAT NOTHING LIKE THIS HAS EVER BEEN PUBLISHED BEFORE.

The book comes with a heavy colored cover, and is printed throughout on fine-class bound paper. No expense has been spared to make this the outstanding volume of its kind. The book measures 7½ x 10 inches.

This book is sold only at such ridiculously low price because it is our aim to put this valuable work into the hands of 50,000 short wave enthusiasts during the first few months of 1932.

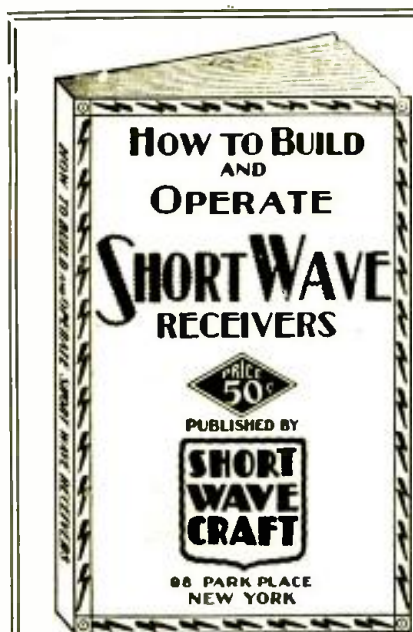

SHORT WAVE CRAFT
98-98 Park Place,
New York City.

Gentlemen:—

I enclose herewith fifty (50c) cents for which please send me upon publication, a copy of your new book **HOW TO BUILD AND OPERATE SHORT WAVE RECEIVERS**. (Send money order, check, cash, or new U. S. Stamps. Register letter if it contains currency or stamps.)

Name

Address

City and State.....

Published by the publishers of **SHORT WAVE CRAFT** magazine. This alone will be your guarantee that it is a really worthwhile publication.

We know that if you are at all interested in short waves you will not wish to do without this book. It is a most important and timely new radio publication.

AUTOMATIC A.C.-D.C. OPERATION

(Continued from page 471)

of the connection in order that the plate current will not seriously modulate the filament current and cause an appreciable hum to be heard. A detailed diagram of the method used in connecting the filaments is shown in Fig. 2. It is seen that the plate current returns to the "B" minus through the center of each series-connection of tubes.

Construction Details

Tubes V1 and V2 are type '22 Areturus; V3 is a type '26; V4 and V5, type '28; and V6, type '30. All have A.C. 15-volt, 35-ampere filaments. Resistors R1 and R2 have resistances of 300 and 100 ohms, respectively, but may be combined into a single 75-ohm unit; R3, 200 ohms; R4, .5-meg. variable resistor; R5, 25-ohm variable resistor; R6, .25-meg.; R7, 1. meg.; R8, .25-meg.

Tuning coils T1, T2 and T3 must be made by the constructor. Each is wound on a tube 1¼ ins. in diameter; the primary having 50 turns and the secondary, 112 turns. Inductances L1 and L2 are R.F. chokes, the writer has used Samson with good results. Coils L3 and L4 are audio-frequency chokes having a value of about 15 henries, L5 are the filter chokes, and may have the same value as the A.F. chokes L3 and L4.

The tuning condensers C1, C2 and C3 are variable and have a maximum capacity of .00035-mf.; C4 is a fixed condenser of .00025-mf.; C5 and C6, fixed condensers of .006-

mf.; C7, C8 and C9 are filter condensers, the first two having a capacity of 2 mf. and the last having a capacity of 4 mf.; C10 and C11, R.F. bypass condensers of .002-mf. each; C12, C13 and C14 are audio blocking condensers of .5-mf.

Operating Precautions

It should be noted that the receiver is not grounded, as experience with D.C. sets has convinced the writer that direct grounding is not necessary and provides another source for the origination of trouble. When used on A.C., one side of the line is always grounded and therefore connects directly to the filament.

When operation on D.C. is desired, care should be taken that the polarity of the line is correct

HANDWRITING ON THE WALL

IT is perhaps a forecast,—that recent experiments conducted by Captain Eaton when he recently flew over Pittsburgh in his bombing plane and, by projecting a beam of light from a special 250-watt, 50 lb. searchlight, 18 ins. in diameter, actuated a light-sensitive cell, and, in turn a flare, located atop the William Penn Hotel. Perhaps future demands of war will call for a special corps to scour all areas accessible to overhead light beams, for possible photoelectric cells wired to caches of remote explosives.

1931-1932 WINTER EDITION RADIO CATALOG

COAST TO COAST RADIO CORPORATION

123-R West 17th St., New York

ORDER from this page
To obtain new customers, the merchandise below is specially priced! We accept checks, stamps and money orders. C.O.D. Shipments are cheerfully made on receipt of a 20% deposit remittance. You may deduct a 2% discount only IF YOU SEND YOUR FULL REMITTANCE WITH THE ORDER.

JUST OFF THE PRESS!

FREE! You cannot possibly afford to be without this money-saving book. It is not just another Catalog, it is indeed a veritable ENCYCLOPEDIA of the RADIO INDUSTRY. **WHOLESALE PRICES TO ALL.**

Guarantee
All our merchandise is fully guaranteed. The House of "COAST TO COAST" is RESPONSIBLE—and you may supply order from us WITH EVERY CONFIDENCE! Our Banking affiliation is THE NATIONAL CITY BANK, New York City.

Super-Heterodyne 10 to 200 Meters and 200 to 550 Meters Variable Mu Pentode Push-Pull 10 Tube A.C. Set.



Automatic Wave Band Switch!
Two chassis construction, 11 1/2 in. long, 9 1/2 in. deep, 8 1/2 in. tall, and 13 1/2 in. long, 9 1/2 in. deep, 8 1/2 in. tall. Requires in all: 3-35, 2-21, 2-27, 2-47, 1-80, 4 Gang condenser, Linear Power Detector, Giant Size POWER PACK! Fully shielded. Black slivered chassis. POLYMET PARTS USED. TONE CONTROL, SELF CONTAINED ANTENNA, PIONEER RADIO SWITCH, TRAVELING SPOT LIGHT VERNIER DIAL—a hundred other features! Instructive detailed blue-prints—instructions included.

Semi-Assembled **\$39.75**
Factory Wired **\$51.95**
Jensen "Concert" 11 1/2 Inch D.C. Dynamic Speaker \$7.95

250 Loftin-White Direct Coupled Amplifiers



Beautiful modern chassis construction. Equipped with TONE CONTROL—VOLUME CONTROL—PHONO-RADIO SWITCH—TWIN JACKS, for Input, Phono Pick-Up and Additional Dynamic Speakers (A.C.). Requires 2500 ohm field D.C. Speaker—Amplifier furnishes field current excitation. Gives "PHENOMENOUS UNDISTORTED VOLUME." 13 1/2 in. long, 9 1/2 in. wide, 8 1/2 in. tall.

Requires 1-24, 1-50, 1-81
Semi-Assembled **\$19.75**
Factory Wired **\$26.75**
Jensen Matched "Concert" 11 1/2 In. Diameter Dynamic Speaker \$8.95

Polymet Power Transformers



All properly center tapped. BRAND NEW. FULLY GUARANTEED!
171A MODEL
Furnishes 550 Volts, A.C. High; 2.15 Volt windings for up to 5-26; 1.25 Volt winding for 1 or 2-27; 1.5 Volt winding for 1 or 2-71A; 1.5 Volt winding for 1-80.

245-247 MODEL
Furnishes 750 Volts (at 100 Mills D.C., 85 Watts) A.C. High; 1.25 Volt winding for up to 7-25 Volt tubes; 1.25 Volt winding for 1 or 2-17 or 1-17; 1.5 Volt winding for 1-80.

250 MODEL
Furnishes 1300 Volts (180 Mills D.C., 175 Watts) A.C. High; 1.25 Volt winding for up to 8-25 Volt tubes; 1.75 Volt winding for 2-70; 1-75 Volt winding for 2-81.

Phono Needle Test Leads



Needle contact pierces insulation of wire, and is held in place through rust, corrosion, or any high resistance coating. PERMITS 100% ACCURACY in meter readings. Replace phono needle as desired—merely insert chuck. Red and black handles. 5 1/4 in. long!

Per Pair **95c**

Super-Heterodyne 10 to 200 Meter Short-Wave Converter with Rotary Wave-Band Selector Switch.

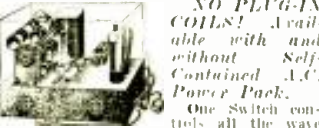

NO PLUG-IN COILS! Available with and without Self-Contained A.C. Power Pack.
One Switch controls all the wave lengths selection! Makes a SUPER-HETERODYNE SHORT-WAVE RECEIVER out of ANY BROADCAST RECEIVER without changing a wire! At the same time, you can receive 200 to 750 meter broadcasts, at will at the throw of a Switch! GIVES WORLD WIDE SHORT-WAVE RECEPTION. Excellent for TELEVISION RECEPTION! Enclosed in a FULLY SHIELDED METAL CASE of unusual beauty.

Requires 1-224, 1-227, 1-280 Tubes LESS A. C. SUPPLY
Semi-Assembled **\$17.50**
Factory Wired WITH SELF-CONTAINED A.C. SUPPLY **\$24.50**
Semi-Assembled **\$23.50**
Factory Wired **\$28.50**

Automatic Wave-Band Switching (10 to 200 Meters) Screen Grid Pentode Push-Pull Short Wave Receiver.



A.C. Model requires 1-221, 1-227, 2-217, 1-280 Tubes. No Plug In Coils required! Furnishes FIELD EXCITATION to a 2500 ohm D.C. DYNAMIC SPEAKER. Enclosed in a very attractive, FULLY SHIELDED METAL CASE. LESS POWER PACK

Semi-Assembled **\$19.50**
Factory Wired WITH SELF-CONTAINED A.C. PACK **\$24.50**
Semi-Assembled **\$29.50**
Factory Wired Jensen 11 1/2 In. "Concert" D.C. Dynamic Speaker **\$7.95**

Automatic Wave-Band Switching Super-Heterodyne Short Wave Coil Assembly.

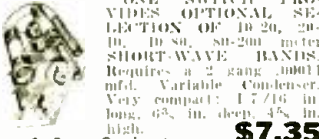

ONE SWITCH PROVIDES OPTIONAL SELECTION OF 10, 20, 50, 100, 1000, 500-200 meter SHORT-WAVE BANDS. Requires a 2 gang .0001 mfd. Variable Condenser. Very compact! 1 7/16 in. long, 6 3/8 in. deep, 4 5/8 in. high.

Less 2 Gang Condenser With 2 Gang .00014 Hammarlund Variable Condenser **\$10.17**

Jensen "Concert" D.C. Dynamic Speakers

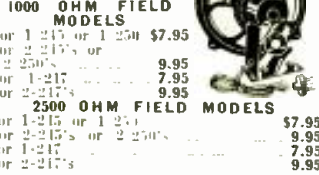

11 1/2 in. Diameter. Complete with Voice Coil Impedance Matching Transformer.
1000 OHM FIELD MODELS
For 1-24's or 1-25's **\$7.95**
For 2-21's or 2-25's **9.95**
For 1-217 **7.95**
For 2-217's **9.95**
2500 OHM FIELD MODELS
For 1-215 or 1-217 **\$7.95**
For 2-215's or 2-250's **9.95**
For 1-217 **7.95**
For 2-217's **9.95**

9 Tube Super-Heterodyne "Coast to Coast" Variable Mu-Pentode Push-Pull Receiver.

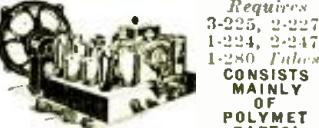

All the parts come to you bolted in a durable and attractively finished steel chassis, measuring 15 in. long, 11 1/2 in. wide, 8 1/2 in. tall. Note also the 3 Electrolytic Condensers (21 Mfd. Total)—assuring Hum-Free Reproduction! Exclusive Features: High-shielded 1-gang Ameco-De Jur Oscillator Tracking Section Condenser, Traveling Spot Light Vernier Tuning Dial, Three 175 K.C. Shielded I.F. Units, Band Pass R.F. Transformer, Twin Jacks for Phono Pick-Up (or Microphone), and additional Dynamic (A.C.) Speaker (or up to 100 Magnetics or Television Lamp, Shielded R.F. Tubes, Volume Control, Tone Control, A.C. Line Switch, Phono Pick-Up, Radio Switch, Socket Provision for connections of 5 Prong Speaker Plug. Furnishes FIELD EXCITATION for a 2500 ohm D.C. DYNAMIC SPEAKER.

Semi-Assembled **\$34.50**
Factory Wired Matched Jensen "Concert" D.C. Dynamic Speaker **\$44.50**
Matched Jensen "Concert" D.C. Dynamic Speaker **\$11.45**

Super-Heterodyne Screen Grid 235 or 224 Coil Kits



Equipped with an Ameco-De Jur 4 Gang .00036 mfd. Variable Condenser with Oscillator "Tracking Section".
Ideal for home construction of SINGLE SPOT—NON SQUALLING—10 KILO-CYCLE TUNED "STEEPS". This identical kit is used in the above described "Super". Contains three 175 K.C. I.F. Transformers; 1 Oscillator and Mixing Coil; 1 Antenna, Band Pass and R.F. Coils; two 8 mil. R.F. Chokes; one 4 Gang Condenser; 1 Wiring Diagram.

Special Free Offer
With every Kit, we include FREE a 125 page book by John E. Rider entitled **Servicing Super-Heterodynes** Complete **\$12.95**

General Electrical Synchronous Phono Motor



Complete with a felt lined turn-table. Turntable revolves at the exactly prescribed rate, despite any voltage variations. Only 3 1/4 in. deep! For 110 volt, 50/60 cycle A.C. **\$3.75**

R.C.A.-Victor-Kellogg Recording and High Gain Speech Microphone



For hand use—5 1/2 in. long. HIGHEST QUALITY OR TAINABLE! **\$3.95**

Four-in-One Serviceman's Neutralizer-Compensator and "Tool Kit"

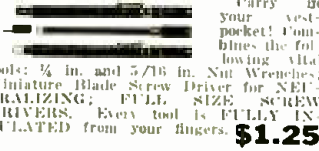

Carry in your vest-pocket! Combines the following: Dial tools: 3/4 in. and 5/16 in. Nut Wrenches; Miniature Blade Screw Driver for NEUTRALIZING; FULL SIZE SCREW DRIVERS. Every tool is FULLY INSULATED from your fingers. **\$1.25**

8 Tube Variable Mu-Pentode Push-Pull Kit

Consists of 3-235 Variable Mu T.R.F. Stages, 1-235 Linear Power Detector, 1-227 Resistance Coupled 1st A.F. Stage, 2-247 Pentode Push-Pull Stages, 1-280 Heavy Duty Power Pack.

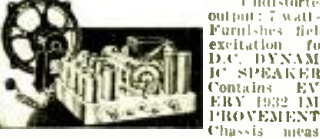

Undistorted output: 7 watt-1! Furnishes field excitation for D.C. DYNAMIC SPEAKER. Contains EVERY IMPROVEMENT! Chassis measures 15 in. long, 11 in. deep, 7 in. high. SEMI ASSEMBLED—a self explanatory diagram is included. THE IDEAL RECEIVER FOR LESS! Dynamic Speaker **\$24.50**
Matched Jensen 11 1/2 In. Diameter "Concert" D.C. Dynamic Speaker **\$11.45**

3 Stage Dual Push-Pull 250 Mercury Rectifier Operated Public Address Amplifier



Requires 1-224, 2-227, 2-250, and 1 Mercury Rectifier!
Undistorted Output: 12.9 Watts (Conservative WESTERN ELECTRIC STANDARD). Equipped with a TONE CONTROL, VOLUME CONTROL, PHONO-RADIO SWITCH, A.C. Line Switch, Phono Pick-Up or MICROPHONE JACK; Additional Speaker Jack; Provision for furnishing any RADIO TUNER with variable "B" voltages and A.C. filament supply; 180 mil. Polymet A.C. Transformer; furnishes field excitation for up to 5 D.C. DYNAMIC SPEAKERS; and a host of other vitally important and valuable features. Handsome black slivered chassis—17 1/2 in. long, 9 in. wide, 8 1/2 in. high.

Semi-Assembled Kit **\$42.40**
Factory Wired Matched 11 1/2 in. Diameter Jensen "Concert" Dynamic Speaker **\$52.40**
Jensen "Concert" Dynamic Speaker **\$10.95**

Magnetic Speaker Chassis



Burtex cloth diaphragm. Over-size tungsten steel magnet. Will NOT DISTORT or RATTLE—despite terrific volume requirements! Over all diameter sturdy steel chassis: 9 in. x 5 1/2 in. deep! The shell partly serves as a SELF RAFFLE! Ideal for use in MULTI-SPEAKER PUBLIC ADDRESS INSTALLATIONS. Each **\$2.95**

Polymet Dry Electrolytic Condensers



500 Volt D.C. Peak Rating! Offers the VARIABLE VOLTAGE of GREATER MICRO-FARAD CAPACITY in considerably diminished space—and at a TRIFLING COST! Mount in any position. Sold on a 100% GUARANTEE BASIS!

One half smaller than the usual type of Electrolytic.

Total Cap.	No. of Sections	Cap. of Each Section in Mfd.	OUR PRICE
4 mfd.	1	4	64c
6 mfd.	1	6	70c
8 mfd.	1	8	76c
8 mfd.	2	4	1.48
12 mfd.	2	6	1.80
16 mfd.	2	8	1.80
14 mfd.	2	6.8	1.66
12 mfd.	3	4.4	2.20
18 mfd.	3	6.6	2.40
21 mfd.	3	8-8.8	2.63



GREATEST MAGAZINE IN SHORT WAVES



On All Large Newsstands
4-Color Cover
9"x12" in Size
Over 200 Illustrations

RAPIDLY increasing each day are the number of experiments in the Short Wave field—developments which are bringing to this branch of radio thousands of new "thrill seekers." Experimenters, as in the early days of Radio, again have the opportunity to bring about stirring new inventions. Read in *SHORT WAVE CRAFT*, the *Experimenter's Magazine*, how you can build your own Short Wave Sets, both transmitters and receivers. *SHORT WAVE CRAFT* is exclusively a short wave magazine—the kind you have wished for so long.

Interesting Articles in the Current Issue

- How to Build New "Plugless" S-W Converter for Broadcast Sets
- Inexpensive Phone Transmitters
- Experimenting with Quasi-Optical Waves.
- Practical hints on A.C. operation of S-W Receivers
- Single Side-band Transmission
- Building a Simple and Inexpensive "Amateur Band" Receiver
- Keying with a "Vacuum Contact" Relay

SPECIAL OFFER COUPON

SHORT WAVE CRAFT RC-2
98 Park Place, New York, N. Y.

I enclose herewith my remittance of \$1.25. (Canada and foreign \$1.50) check or money order preferred, for which you are to enter my subscription to *SHORT WAVE CRAFT* for One Year, also send me the last two issues gratis. I understand that the regular subscription rate is \$1.50 and this offer will be void after January 31. *SHORT WAVE CRAFT* is published every other month.

NAME
ADDRESS
CITY..... STATE.....

"MIKE" MIXERS

(Continued from page 498)

Parts Used

- Four Duo-type 300-ohm constant-impedance pads (Clarostat);
- One Weston 0-50-milliamperemeter;
- Three 200-ohm variable resistors;
- Three 25-mf. Acrovox electrolytic condensers;
- One 2-mf. Acrovox condenser Type 207;
- One 4-mf. Acrovox condenser (electrolytic);
- Three microphone mixing transformers 200-ohm input and 200-ohm output;
- One matching transformer 500-ohm input to grid of type 230 tube;
- One impedance-matching transformer input from plate of type UX 230 to 200-ohm output;
- One 20-ohm resistor (variable);
- Five "on" and "off" switches;
- One 45-volt "B" battery, Burgess;
- One 4½-volt "C" battery, Burgess;
- Two No. 6 dry cells, Burgess;
- Six two-way push buttons.

CODE WIRING

(Continued from page 504)

extinguish the fire, little damage will perhaps be done, but if not, a four-alarm fire may develop. Most of this type of work is done in the older types of buildings and many of them are of tinder-box construction, just waiting for the spark to start a roaring furnace.

"Another practice is the use of 30-ampere fuses on branch circuits. Since these are wired with No. 14 wire which has an allowable carrying capacity of 15 amperes, a 30-ampere fuse does not constitute a proper overload protection; 15-ampere fuses blow because more than 15 amperes flow through them and placing a heavier fuse in the cut-out merely overloads the wires and transfers the possible point of burn-out to some other part of the circuit. Repairs at that point will always cost many times the price of a fuse.

"As a final word, I think that radio men are compelled to work too fast for good work. More time should be allotted to each job, and radio set buyers, figuring the entertainment they will receive from the set and the cost to them if they were to buy this entertainment at box office prices, should not begrudge the money for a decent job. If they were to demand and get certificates of approval on their radio installation as both the law and their insurance policy direct, the same as they get when they do any other wiring, both they and the radio Service Man will be the gainer. We do not quarrel with any man's right to make a living, but when this method of making a living involves possible danger to life and property of himself and others, civilized life demands that this man be subject to whatever rules are found necessary to minimize this danger."

Fire Departments also have much to say about radio Service Men, as have also apartment house superintendents, chief engineers in apartment hotels, master electricians like the writers who have also been in the radio business since its infancy, and a number of others whose lives or businesses are touched by the Service Man.

Index to Advertisers

A	
American Technical Society	484
Amperite Corporation	503
Arco Tube Company	500
B	
Blair the Radio Man, Inc.	503
C	
Cable Radio Tube Corp.	Inside Front Cover
Capitol Radio Engineering Institute	503
Carolina Crest Hotel	507
Central Radio Laboratories	491
Chemical Institute of N. Y.	490
Clarostat Mfg. Company	501
Classified Section	500
Coast-to-Coast Radio Corp.	505
Coyne Electrical School	451, 497
Crosley Radio Corp.	495
D	
Drake Hotel	507
Dubilier Condenser Corp.	488
E	
Electrad, Inc.	494
Electrical Mfg. Corp.	490
F	
Filtermatic Mfg. Company.....	492
Flanders Hotel	507
G	
Gernsback Publications, Inc.....	452, 502
Gernsback Corp., S.	492
Grant Radio Laboratories	492
Grenpark Company	510
H	
Hollywood Restaurant	507
Hoodwin Company Chas.....	494
I	
International Resistance Company	485
J	
Johnson Radio Mfg. Company	494
L	
L. & I. Electric Company.....	494
Lincoln Mfg. Company	456
Lynch Mfg. Company	484
M	
Midwest Radio Corp.	454
Miles Mfg. Company	484
N	
National Radio Institute	487, 512
New Bismarck Hotel	507
P	
Pilot Radio & Tube Corp.	455
Police Lowwave Laboratories	492
Polymet Mfg. Company	486
Popular Book Corp.	504
Press Guild, Inc.	496
R	
Radio & Television Institute	501
Radio Circular Company	511
Radio College of Canada	490
Radio Service Shop	494
Radio Surplus Corp.	498
Radio Trading Company	509
Radio Training Association of America, Inc.	449
Radio Training Schools, Inc.....	483
Radolek Company	488
RCA Institutes, Inc.	493
RCA-Victor Company, Inc.	Back Cover
Readrite Meter Works	499
Ross, Malcom	494
Roth Press	498
Royal Palm Hotel	508
Russian Village	507
S	
Scott Radio Laboratories, Inc., E. H.	453
Short-Wave Craft	506
Silver-Marshall, Inc.	481
Supreme Instruments Corp.	489
U	
Universal Microphone Company	486

(While every precaution is taken to insure accuracy, we cannot guarantee against the possibility of an occasional change or omission in the preparation of this index.)

FEBRUARY SPECIALS !!

WE are announcing an important new departure this month. Every month we will show on this page certain **STAR** items, which are **NOT LISTED IN OUR CATALOG**. These are all specials of which the quantities on hand are not sufficient to catalog them. *Once sold out, no more can be had.*

STOP SHOPPING. The lowest prices are right on this page. *No one undersells us.* We meet any price on **ANY NEW Merchandise.** Order direct from this page and save money. 100% satisfaction on every transaction. Take advantage of these special offers. **ORDER NOW, TODAY.**



NEW! "LITTLE GIANT" DYNAMIC SPEAKER

Absolutely the smallest dynamic speaker that will withstand the strain of modern output power tubes, expertly manufactured.

Suitable for use on cabinet, portable and automobile receivers. Measures but 6 1/4 in. long over-all, having a 1 1/2 in. diaphragm and weighing but 1 lb. The "Little Giant" has, under test, actually flooded a ten-room apartment with faithfully reproduced music of virtually original tone quality. Field winding has a resistance of 2500 ohms and may therefore be energized by using it as a filter choke in the power pack, thereby serving a double purpose. This last feature makes the "Little Giant" excellently suited for portable A.C. sets, since it does away with filter chokes and thus with considerable weight. Equipped with built in output transformer to work from any standard output power tube arrangement. Specify the power tube or tubes used when ordering. Shipping weight 5 lbs. List Price \$6.50. No. 1549. **LITTLE GIANT DYNAMIC SPEAKER. Your Price \$2.50**



***RCA VICTOR 11-INCH DYNAMIC SPEAKER**

For 110-20 Volts 60 Cycle Operation

A superior, heavy duty unit embodying all the fine principles of construction and operation typical of all RCA and Victor radio equipment. Designed especially to accommodate a large theatre, hall, armories and outdoor stadiums. Includes a completely shielded, heavy duty power transformer feeding a type 280 full wave rectifier which energizes the field coil with smooth, unflaring current. In addition this current is thoroughly filtered by an 8 mfd. electrolytic condenser which completely reduces hum to an absolute minimum. A special high quality output transformer, to operate out of any standard arrangement of power tubes, is furnished with each unit (specify the type of power tube or tubes employed when ordering). Both speaker and electric cords and plugs are supplied with speaker as is the "80 rectifying tube.

The over-all dimensions are 12" high, 12" wide and 8 1/2" deep. Provided with adequate mounting facilities.

A 9" corrugated cone insures strength and durability under the most powerful operating conditions. Capable of handling a tremendous amount of volume without distortion. Designed for 110-20 volts 50-60 cycles. Shipping weight—32 lbs. List Price, \$25.00. No. SP9056—**RCA Victor Dynamic Speaker, Your Price... \$13.50**

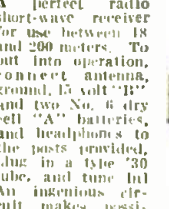

World-Wide Short-Wave Set NOT A CONVERTER

A perfect radio short-wave receiver for use between 18 and 280 meters. To put into operation, connect antenna, ground, 1 1/2 volt "B" and two No. 6 dry cell "A" batteries, and headphones to the posts provided, plug in a type 30 tube, and tune in! An ingenious circuit makes possible a 4-coil single-winding plug-in design. This little instrument has the same sensitivity as many big, shielded short-wave receivers costing ten times as much. A power amplifier may be added for any degree of volume. Complete with 4 plug-in coils. Has fine vernier dial for precision tuning. **Never has a first class short-wave set sold for so little money.** This short-wave set measures 5 1/2 x 7 1/2 in. high, over all. Shipping weight, 3 lbs. List price, \$12.50. No. 1666—**World-Wide S. W. Set. Your price... \$6.25**



***SERVICEMEN'S SPECIAL TEST PRODS**

Here's what every serviceman and experimenter has been waiting for—test leads that **CAN PIERCE THE TOUGHEST OF WIRE INSULATION AND TAKE VOLTAGE AND OTHER MEASUREMENTS WITHOUT THE NECESSITY OF STRIPPING WIRES.** These test prods are so constructed that instead of the usual phone-tins, adjustable chucks, capable of securely gripping steel phonograph needles, are permanently attached to the ends of the insulated handles. The use of these prods completely eliminates the introduction of errors in meter readings caused by poor-contact resistance or resistance resulting from the presence of dirt and grit. Five feet of flexible, color-coded leads, securely soldered to the metal chucks insures permanent and positive electrical contact. The other ends of the test leads are provided with convenient U-shaped connection lugs. Shipping weight—1 1/4 lb. List Price, \$1.40. No. SP9055—**Servicemen's Special Test Prods. Your Price... \$.35**



***FLECHTHEIM PORTABLE VOLTMETERS**

Flechtheim superior built instruments have well earned a reputation of reliability for their unusual life and accuracy in actual use. These voltmeters which are available in two types, namely, 0 to 500 volts D.C. and 0-500 volts A.C. and which have an internal resistance of 60 ohms per volt are sturdily and attractively constructed in a nickel-plated, highly-burnished protective shield case. The scales are evenly and accurately calibrated so that although the range is higher than 500 volts, the comparatively low voltage of 5 can be easily and quite accurately recorded. Each meter is of the portable type, being provided with convenient mounting rings for hanging on walls or test panels. Sold complete with 3 ft. flexible test leads provided with phosphor bronze, non-corroding test tips and non-breakable color-coded insulated handles. Shipping weight—1 lb. List Price, \$7.50. No. SP9051—**0-500 DC Voltmeter. No. SP9052—0-600 AC-DC Voltmeter—Your Price... \$3.25**



***WEBSTER "250" POWER AUDITORIUM AMPLIFIER**

Contains 2 Stages Super Power A.F. Amplification.

NOW \$18.00 Less Tubes

ONE OF THE MOST POWERFUL SUPER POWER AMPLIFIERS EVER MADE.

Ideal for theatres seating approximately 3,000 people, dance halls, schools, lectures, hospitals, auditoriums, outdoor gatherings, etc., etc. The elegant power is at all times within control—for that matter it can be used in any home, as the volume can be regulated down to a whisper! But most important of all, the **QUALITY OF REPRODUCTION IS AS NEAR PERFECT AND LIFE-LIKE AS POSSIBLE; ITS POSSIBILITIES CAN BE SUMMED UP IN THREE WORDS: ABSOLUTELY DISTORTIONLESS VOLUME!** The full benefit of the 150 volt produced is obtained.

This famous amplifier is provided with a high quality input transformer for working from a phonograph pick-up or single or double button microphone.

The tubes required are 1 '26, 1 '50 and 1 '81 rectifier. Where the maximum output is not required a '10 may be substituted for the '50 in the output. Automatic adjustment takes care of the discrepancy in voltages.

The undistorted power output is 25 watts—**ENOUGH FOR FOUR DYNAMIC REPRODUCERS.** This degree of power output provides satisfactory coverage for auditoriums having volume of 25,000 cubic feet when used with a dynamic speaker having a flat baffle board, 50,000 cubic feet when used with a speaker having a directional baffle or horn.

Over-all dimensions are 15" long by 10" wide by 6 1/2" deep. Shipping weight—31 lbs. List Price, \$45.00. No. SP9059—**Webster "250" Power Amplifier. Your Price... \$18.00**

FREE 76 Page Radio Treatise No. 24



The new Winter edition of our **RADIO SERVICE TREATISE**, twice as large as our former one, has just come off the press. It is positively the greatest book in print—**NOT JUST A CATALOG.** It contains a large editorial section—a veritable book in itself—with valuable information **NOT FOUND ANYWHERE ELSE.** Among the wealth of new technical information listed in the editorial sections are the following: 1932 Complete Radio Characteristics **SHORT-WAVE TUNERS** and **PHONO-PICKUPS**—**CONSTRUCTIONAL DATA OF SERVICEMEN'S TEST OSCILLATOR—ALL ABOUT TONE CONTROLS—SHORT-WAVE ADAPTERS AND CONVERTERS—CONSTRUCTING A 3-TUBE SUPER-HET SHORT-WAVE CONVERTER.—MODERNIZING OLD RADIO SETS.—LATEST TYPE MULTI-TUBE AND PENTODE TUBES.—ALL ABOUT DC RECEIVERS.—VACUUM TUBES TREATISE.**—And dozens of new radio experiments, hints to Servicemen, valuable tables of useful data, etc., etc.

This book is not just another catalog but a veritable mint of radio information which will be of infinite and everlasting value to you.

100 New Hook-Ups, etc. 675 Illustrations.

WRITE TODAY. Enclose 2 cents for postage. Treatise sent by return mail.

6 MONTHS GUARANTEED NEONTRON TUBES

Sold on a 6 MONTHS FREE REPLACEMENT GUARANTEE BASIS, PROVIDING TUBE LIGHTS! All tubes are carefully meter tested before shipment, and carefully packed. Do not confuse these **HIGH QUALITY** tubes with any other "low priced" tubes—our low prices are possible because we do a **VOLUME** business!

Choice	Choice of	Choice	Choice	Choice	Choice
226	112A	215	222	230	237
227	200A 189X	280	210	232	247
171A	189V-120	171	250		234
201A	224		281		236-37
					351

60c ea. 69c ea. 70c ea. 1.58 ea. 1.08 ea. 1.08 ea.

R.C.A. LICENSED TRIAD AND PERRYMAN TUBES

These nationally advertised tubes are guaranteed UNCONDITIONALLY for six months. The prices are slightly higher than our NEONTRONS because these tubes are of much better quality. See listing above for tube numbers.

Choice Price	Choice Price	Choice Price	Choice Price	Choice Price	Choice Price
63c	80c	75c	\$1.76	\$1.15	\$1.15



***MICROPHONE PRE-AMPLIFIER**

An extremely compact and efficient unit designed to "boost" the weak microphone currents to proportions which will correctly match the input stages of all type amplifiers. May be used with either one or two-button microphones. This pre-amplifier unit provides a "booster" circuit with transformer, variable volume control and battery receptacle and switch, all contained in a neat metal-shielded case beautifully scribed in black enamel and with polished aluminum face. The case measures 6 1/2 x 3 1/2" deep and is provided with soft rubber feet. Sold complete with 1/2 volt microphone battery. Shipping weight—10 lbs. List Price, \$15.50. No. SP9057—**Microphone Pre-Amplifier. Your Price... \$7.50**



***6-VOLT BATTERY PHONO-MOTOR**

At last a **REAL** battery motor—designed especially to meet the needs of semi-portable and portable address systems especially installations on marine vehicles. It will easily and economically operate from 6 volt storage battery or the equivalent in dry cells. Draws very little current. The entire motor is flexibly pivoted upon a cast metal frame and is held taut at all times by a compensating spring, thus assuring positive contact of the friction drive gear against the inside rim of the turntable. This arrangement was designed to overcome the effects of bumps and jars experienced by marine vehicles. The motor is sold complete with 10 ft. removable mounting plate and motor switch and speed control. Shipping weight—10 lbs. List Price, \$15.00. No. SP958—**6 Volt Battery Phonomotor. Your Price... \$2.50**



***JEFFERSON POWERPACK—CHOKE UNIT**

For '26, '27, '71A and '80 Tubes

This unit consists of a standard Jefferson Power transformer and a 30 Henry 500 ohm filterchoke. Both are mounted in a sturdy, compact metal case, equipped with convenient terminal strips and mounting flanges. **JUST THE THING TO CONVERT OLD TYPE BATTERY SETS INTO MODERN ALL-ELECTRIC AC RECEIVERS.** The power transformer will safely handle 5-225's, 2-227's, 2-171A's and a '80 rectifier. The filter choke is of standard design and has sufficient D.C. resistance to cut down the high voltage to the requisite 180 volts for the plates of the 171A power tubes. The only additional parts necessary to construct a complete power pack for AC receivers, power amplifiers or public address systems are a filter condenser bank and a voltage divider. These latter units can be furnished on request.

Complete instruction for hooking up and wiring is supplied with each unit. Shipping weight—10 lbs. List Price, \$10.00. No. SP9053—**Jefferson Power Pack \$2.75 Choke Unit. Your Price... \$2.75**



***Guaranteed 8-Mfd. Electrolytic Condensers**

Judiciously used in many parts of any R.F. or A.F. circuits, in power packs, in dynamic speakers, they will perform miracles in eliminating any trace of objectionable A.C. hum or other incidental disturbances. These electrolytic condensers are particularly recommended for 250 power packs. Where the working voltage of the unfiltered A.C. is 800 volts, two electrolytic condensers in series, will stand up indefinitely. Easily mounted through the use of a bayonet socket base which is equipped with a "spring contact" spring. Totally shielded and protected by a copper cap. Shipping weight—1 lb. List Price, \$2.50. No. SP9054—**Guaranteed 8 Mfd. Electrolytic Condenser. Your Price... \$.49**

WE ARE A WHOLESALE HOUSE AND CANNOT ACCEPT ORDERS FOR LESS THAN \$3.00.

If C. O. D. shipment is desired, please remit 20% remittance, which must accompany all orders.

If full cash accompanies order, deduct 2% discount. Send money order—certified check—U. S. stamps.

Radio Trading Co.
23 West Broadway
New York, N. Y.

ORDER FROM THIS PAGE. You will find special prices from time to time in this magazine. Get our big **FREE** catalog for the greatest Radio Bargains.

Should you wish goods shipped by parcel post, be sure to include sufficient extra remittance for same. Any excess will be refunded.

\$100,000 Speaker Sale!

Included in this tremendous speaker sale are the products manufactured by leading speaker makers. Every speaker is brand new and shipped in original factory sealed cartons. They are sold far below their regular list price because they were bought in exceedingly large quantities and our purchase price permits us to give you the benefit of low cost.



DUO MAGNETIC

Duo Magnetic Speaker ... **\$3.95**
 Duo Inductor Dynamic Chassis ... **\$3.95**
 Similar to Farrand Inductor.

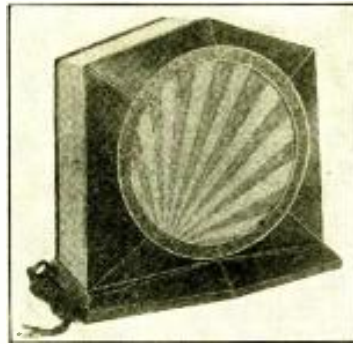

R. C. A. 100 B

Famous R.C.A. 100B Magnetic Speaker sold first time at this cut price.

\$4.50

JENSEN

A.C.—D.8 Dry Rectifier **\$14.95**
 A.C.—D.7 Jr. Audit Tube Rect. **\$12.95**
 A.C.—D.15 Concert Jr. Tube Rect. ... **\$8.50**
 D.9—2500 OHM D.C. Field ... **\$7.50**
 D.7—2500 OHM D.C. Field ... **\$8.50**
 D.15—Midget Concert Jr. 2500 OHMS — **\$4.75**



OXFORD

A. C. Models
 14" Audit using 280 Rect **\$12.95**
 12" Concert Dynamic 280 Rect **\$8.95**
 9" Midget Dynamic 280 Rect **\$7.50**
 D. C. Models
 14" 5000 OHM Field ... **\$8.95**
 11" 2500 OHM Field ... **\$4.95**
 9" 2500 OHM Field ... **\$3.49**
 All 9" Midgets are supplied with Hum balancer



MAGNETIC SPEAKERS IN BOSCH CABINETS

Due to the many battery operated sets still in use which require magnetic speakers, we offer the following in the beautiful Bosch cabinet.
 B. B. L. ... **\$4.50**
 Bosch ... **\$4.95**
 R. C. A. ... **\$4.95**
 Farrand ... **\$4.50**



PEERLESS

A.C. Models
 12" A.C. Using Kodak Double Rect. and 2000 Mfd. Cond. **\$12.95**
 12" A.C. using 280 Tube ... **\$12.50**
 D.C. Model
 12" 1000 OHM Field 110 Volt
 D.C. Line ... **\$6.95**

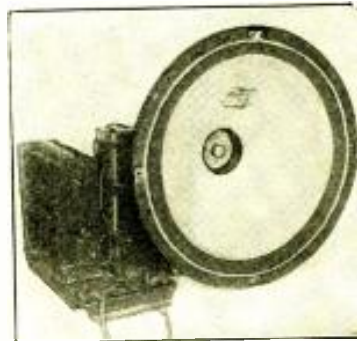

BALDWIN

A. C. using 280 Tube Rect. ... **\$7.50**
 D. C. 2500 OHM—110 Volts ... **\$5.50**
 D. C. 2500 OHM—110 Volts Field ... **\$4.00**
 D. C. 2500 OHM—110 Volts Field Less Output Trans. **\$3.25**



R.C.A. & VICTOR

Victor A.C. Audit Model with Tube ... **\$12.25**
 Victor D.C. Audit 2500 Ohm ... **\$8.95**
 Victor D.C. Audit 2500 Ohms Less output ... **\$7.95**
 R. C. A. A.C. With tube rect ... **\$12.50**
 D.C. 8000 ohm 300 V. Field ... **\$5.50**
 D.C. 8000 ohm 300 V. Field output ... **\$4.50**
 D.C. 800 ohm 110 V. Field 12 ... **\$7.50**

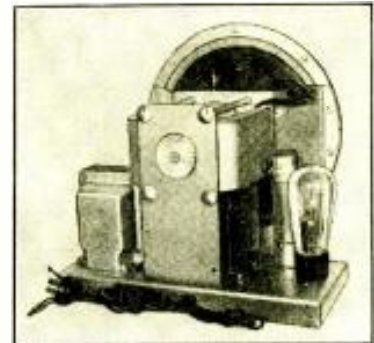

ROLA

A. C. Models
 Model G-90-C A.C. using 280 Rect. ... **\$9.95**
 Model K. Midget A.C. using 280 Rect. ... **\$8.50**
 D. C. Models
 2500 ohm P.P. Output Trans. } **\$4.25**
 1000 ohm P.P. Output Trans. } Each Model
 2500 ohm Single Pentode.
 2500 ohm Push Pull 238.
 1000 ohm Single 238.
 1800 ohm Single Pentode 300 ohm Tap for Bias.



FARRAND INDUCTOR DYNAMICS



Used on A.C., D.C., and Battery Sets with Equal Results.
 9" Model ... **\$5.95**
 12" Model ... **6.95**



PENTODE ADAPTER

This Pentode Adapter permits the insertion of a type 247 Pentode Power Tube in place of the type 245 tube. Simply remove 245 tube, and insert the Adapter, and plug in the 247.
 OUR NET PRICE ... **\$1.20**

Do Not Write For Catalog!

All offers are F.O.B. New York, and subject to prior sale. Terms: A deposit of 20% is required with every order. Balance may be paid on delivery. Or, deduct 2% if full amount is sent with order.

GRENPARK CO., Dept. R.C. 245 Greenwich Street, New York, N. Y.

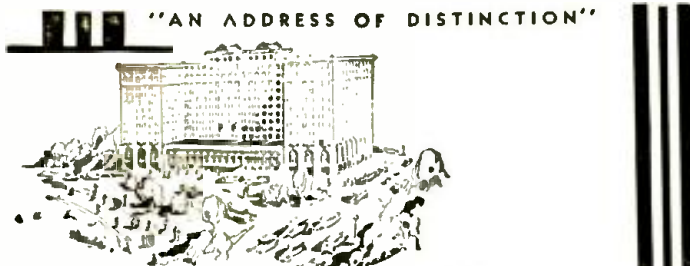

Important Business . . . Calls For An Important Address

To the prestige value of an address of international reputation THE DRAKE adds many accommodations of very practical business value. For instance . . . on request, we gladly place at the disposal of the guest, quarters for large or small conferences. *There is no extra charge* for this service. Mail . . . telegram and phone calls are promptly dispatched . . . numerous experienced, skilled services are available to expedite your business. *Rates begin at \$4 per day.*

THE DRAKE HOTEL, CHICAGO
Under Blackstone Management

HOTEL DIRECTORY OF THE RADIO TRADE

The Hotels on this page are Patronized by the Radio Trade. Make them your Headquarters

One in a Thousand



At 999 hotels in Atlantic City you can get the same thing . . . rooms with or without meals . . .

*An Original and Unique Service has made

THE CAROLINA CREST

The Thousandth Hotel

*Abed or at your service table enjoy a delicious Tray Breakfast WITHOUT CHARGE—in the privacy of your own comfortable room while you glance through your morning paper . . . then wonder—as all our guests do—how we happened to move your home to the

CAROLINA CREST

North Carolina Ave., near Boardwalk ATLANTIC CITY, N. J.

SPECIAL WINTER RATE
\$3.00 per day

Every room with private bath—
Bed lamps and at least three windows.

H. L. FAIRBAIRN, Mgr.

THE SENSATIONAL . . . HOLLYWOOD RESTAURANT
B'WAY. at 48th ST. N.Y.C.
NTG and his NEW REVUE

40 BEAUTIFUL GIRLS 40
To Entertain You While You Enjoy
BROADWAY'S BEST DINNER
\$1.50 \$1.75 \$2.00
At Katz and His Kittens
After Theatre and Late
Supper Shows
12 and 1:30 a.m.
NO COVER CHARGE

*"The Gathering Place of
Cosmopolitan New Yorkers."*
The RUSSIAN VILLAGE
100 West 57th Street
New York City
Dining, Dancing, Russian and Gypsy
Entertainment.
LUNCH — TEA — DINNER
No cover charge at any time.
Broadcasting WOR Circle 7-9434



For Convenience and Comfort

come to the Bismarck . . . right in the heart of the Loop . . . next to the wholesale, financial and theatre district. Large, light, outside rooms with super-comfort beds . . . soft water for your bath . . . room signals indicating the arrival of your mail . . . national reputation for Good Food . . . four distinctive dining rooms . . . courteous hospitality urging you to "come again."
Rooms with bath, \$3.50, \$4.00, \$4.50, \$5.00 and \$6.00
Rooms without bath. \$2.50

NEW BISMARCK HOTEL CHICAGO
RANDOLPH AT LA SALLE

THE NEW FLANDERS
THE HONEY HOTEL
Finest Hotel in Times Square
Right in the Heart of Everything
Times Square, 47th to 48th Sts.
East of Broadway
NEW YORK CITY

<i>Rooms with Private Bath</i>	
1 person	\$1.50
<i>Rooms with Private Bath</i>	
1 persons	2.50
<i>Rooms with use of Bath</i>	
1 person	2.00
<i>Rooms with use of Bath</i>	
2 persons	3.00
Large Comfortable Suite—2 or 3 people	5.00

Special Weekly Rates
FRED W. BIZEL, Resident Manager

*A Special Offer to
NEW READERS*
Eight months subscription to RADIO-CRAFT for \$1.00. Send remittance to RADIO CRAFT, 98 Park Place, New York, N. Y.

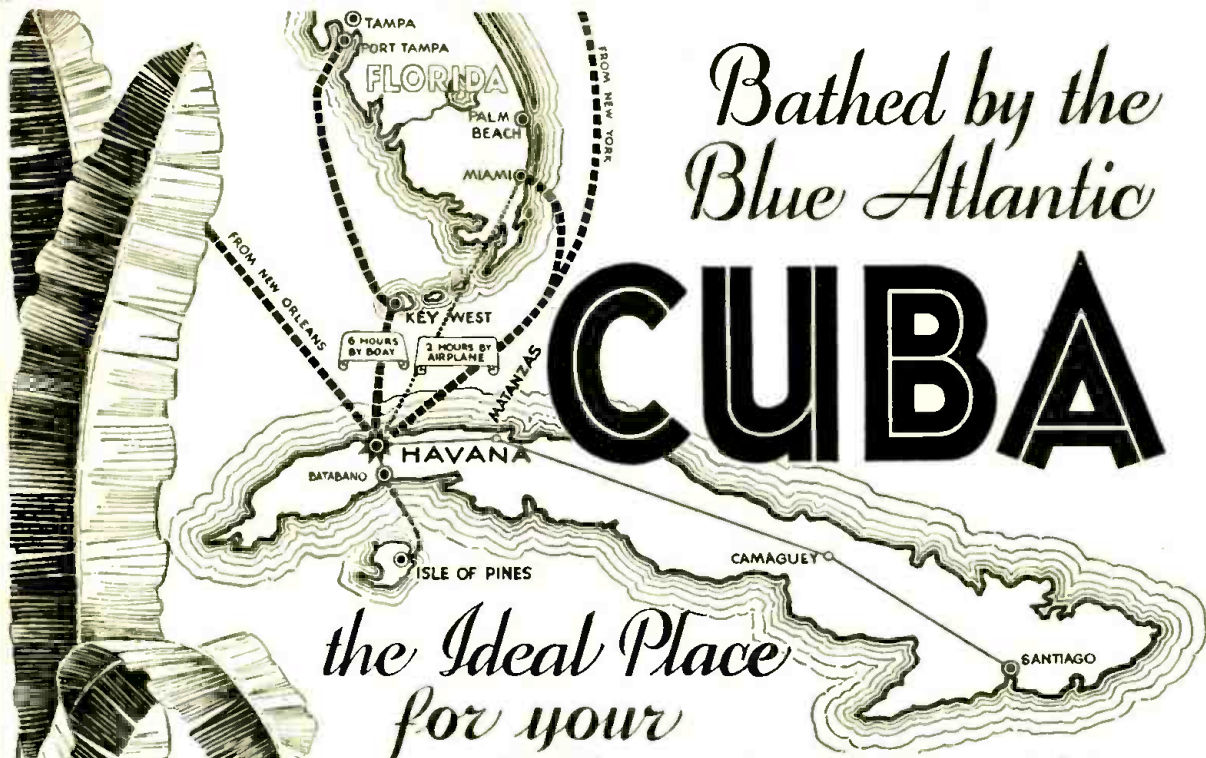

*Bathed by the
Blue Atlantic*

CUBA

*the Ideal Place
for your*

WINTER VACATION

OR FOR A PERFECT HONEYMOON TRIP

The Cuban climate is delightful in winter. You will never forget a vacation spent in the Romantic Old World Atmosphere of this charming island, which is visited annually by hundreds of thousands of Americans.

HOTEL

ROYAL PALM Havana

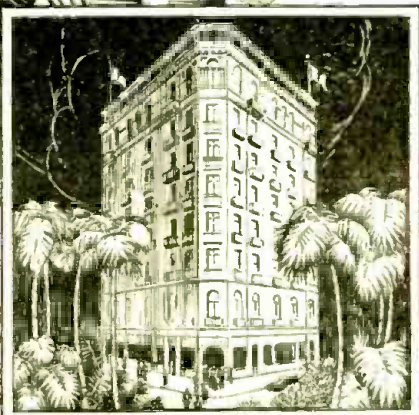

Located in the very heart of Havana's gay social life and the luxurious home of visiting Americans. Overlooking Parque Central and the Prado, it is within a few minutes leisurely walk of shops and department stores.

YOUR CHANCE TO VISIT HAVANA ECONOMICALLY

ROYAL PALM RATES
Reduced 50% this Winter

Havana is just a short inexpensive trip by luxurious steamers, with special excursion rates and frequent sailings from New York, Miami, Tampa, Key West or New Orleans.....

Only 2 hours by Pan American Airways-Express planes from Miami



For complete information, illustrated booklets etc. write direct to the Hotel or to our Chicago Office, Suite 422.. 520 No. Michigan Ave.



Prices YOU can make a REAL profit on!



GENERAL ELECTRIC Phonograph Induction Motor With 12 Inch Turntable

Designed to meet the demand for a reliable, noiseless and non-interfering electrically operated turntable for Phonographs and radio-phonograph combinations. Has double phase, compound wound induction rolls and disc type balanced armature, assuring quiet, smooth operation.

Governor controlled by lever and friction disc, setting of which applies proper torque for R. P. M. Constructed of the finest of electrical and mechanical parts. Equipped with 12 inch turntable. For 110 Volt, A.C.

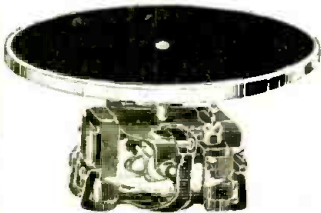

OUR PRICE **\$7.50**

WEBSTER PHONOGRAPH PICKUP



Will faithfully reproduce all frequencies recorded on electrically cut records. Remarkable clearness, and volume are features that prove scientifically correct design. A volume control is built into the base of pickup, allowing a full range of volume control. Cover of pickup head and arm finished in black enamel.

OUR PRICE **\$3.60**

Genuine PHILCO Power Transformers

Philco Part No. 3516, for Philco Models 65, 76, 77, 7A and others using following Tubes: 3-224, 1-227, 2-245, 1-280.

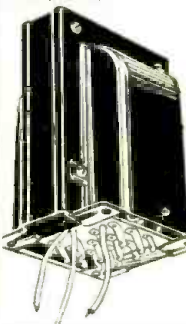

An excellent replacement transformer for most standard sets. Green and black wires, 125 V. Yellow wire C.T. of 7 and 9. Secondary connections shown on diagram.

Size: 3 3/4 in. long, 3 1/2 in. wide, 5 1/2 in. high

1 and 2-5 V. (280); 3-C.T. of High; 4 and 5-High V.; 6 and 10-2 1/2 V. (245); 8-C.T. of 6 and 10; 7 and 9-2 1/2 (227).

OUR PRICE **\$3.15**

Condenser Block for Majestic "B" Eliminator



OUR PRICE **\$2.10**

Replacement for defective blocks in "B" Eliminators—identical in electrical characteristics and outside dimensions. Can also be used in any make "B" Eliminator as well as most power packs

Kolster K-6 Speaker

Magnetic type cone speaker. Remarkable tone quality; volume to spare. Beautifully carved, fine Walnut cabinet. Equipped with highly sensitive oversize magnet and driving unit. Faithful reproduction from the faintest whisper to fullest volume of a brass band.

List \$20.00

OUR PRICE **\$3.35**



R. C. A. Loudspeaker 103

A beautiful speaker, superb in its faithful reproduction. Molded frame and pedestal resemble hand carved oak. Mechanism concealed by attractive tapestry.

(Genuine R.C.A.)

List \$18.00

OUR PRICE **\$3.43**



JENSEN SPEAKER Electro-Dynamic

(Model D7DC)

10 in. "Concert" D.C.

These hum-free units contain suitable push-pull transformers and connect directly to the set on outside wires 2500 ohm field, 8 ohm voice coil. As most standard A.C. sets are built for D.C. speakers of this ohmage, the possibilities for replacement with this really good speaker are unlimited.

Act quickly. Quantity limited.

OUR PRICE **\$8.95**

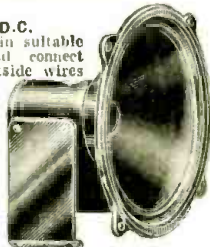

Fixed Pigtail Resistors

OHMS

500	10,000	75,000
1,000	15,000	100,000
1,500	20,000	125,000
1,800	25,000	150,000
4,000	30,000	250,000
4,700	40,000	1 Megohm
5,000	60,000	2 Megohms

OUR PRICE **50c** PER DOZ.

Atwater-Kent Condenser & Filter Block

For Model 37 and 38 Sets. Ideal filtering system for ANY make A. C. set using 171-A tube. Contains proper chokes and high voltage condensers. Flexible wire colored leads same as original.

HOOK-UP

Green wire to 280, black to R.F. plate, yellow to Power Tube plate, white to first audio bypass, white to C.T. of 226 resistance, red to detector plate. Wire from can to ground.

OUR PRICE **\$2.40**



I.C.A. Test Leads—a necessity to the dealer or serviceman. Unsurpassed for testing sets and tracing shorts, opens and other common defects. Easily attached to testing meter or electrical apparatus. **40c**

A. C. DAYTON FLEWELLING SHORT WAVE ADAPTER

A.C. AND D.C. TYPES. This remarkable complete adapter makes a Short Wave Receiver out of any set without change of wiring. Short wave reception covering 18 to 84 meters is accomplished by 3 plug-in coils with non-corrosive nickel plated prongs, which give positive contact. There is nothing else to buy. The adapter is housed in a mahogany finished cabinet. Easy tuning with slow motion, smooth, vernier dial.

Model A.C. IV. For sets using 1X-227 A.C. tubes as first I.F. Amplifier or in the detector socket.

Model D.C. IX. For sets using 1X-201A, 1X-199, WD-11, or A.C. 226 type tubes.

List Price \$15

OUR PRICE FOR A.C. OR D.C. MODEL

\$4.75

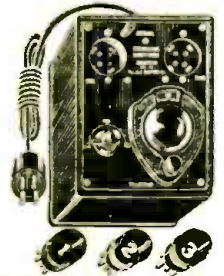

T. C. A. PUSH-PULL INPUT AUDIO TRANSFORMER

Standard replacement transformer for Push-Pull formation using 171, 215, and 250 type tubes. Core of permalloy steel lamination, bound by mounting brackets which serve as shield. Dimensions: 2x3x3 1/2 in.

OUR PRICE

\$9c

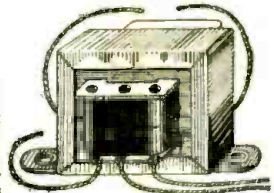

Victor ABC Power Transformer

For use with 6-226, 2-245, 1-227 and 1-280 tubes. Magnetically shielded preventing hum. Can safely be overloaded 30%. High voltages, 400 volts at 150 mills on either side of center tap. Extra large case especially designed to prevent overheating.

No. 1—Center tap of 9, 14—(5 volts).

No. 2, 4—2 1/2 Volts.

No. 5, 7—1 in. V. High amp. (226).

No. 3, 6—Primary (110 V. Input).

No. 8—Center tap of 12, 17—(2 1/2 V.).

No. 9, 14—5 Volts (280).

No. 10, 15—High volt B supply.

No. 16—Center tap of above.

No. 12, 17—2 1/2 in. volts high amp. (224).

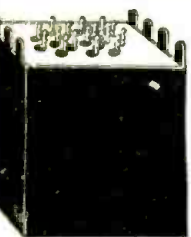

Size: 1 1/2 x 5 x 3 1/2 inches. Can be used for any power amplifier using 215 Tubes.

OUR PRICE **\$1.95**

FREE Catalog—means money to you. These are only a few samples of the values to be found in our catalog. It is full of items on which you can make from 50% to 300% profit. And the best of them is, they are sound, well known, trademarked articles you can depend upon.

Send 20c with the order and articles will be shipped C.O.D. Order any of the above articles direct from this page. And be sure to ask for the catalog. It means money to you!

RADIO CIRCULAR CO.
225 Varick St. New York City

ORDER DIRECT...from this page!

TEAR IT OUT NOW!

RADIO CIRCULAR CO., 225 Varick Street, New York City

Enclosed find \$..... This is 20% of items listed below. I will pay balance upon receipt of merchandise.

We regret that we cannot accept orders under \$5.00

.....

Name.....

Address.....

Also please send catalog.

Send for FREE catalog!

RADIO CIRCULAR CO.
225 Varick Street, New York City

Please send me your catalog of radio bargains I can make a profit on.
I understand this obligates me in no way.

Name.....

Address.....

City..... State.....

I will train you at home to fill a **BIG PAY** Radio Job!



Here's Proof



\$100 a week

"My earnings in Radio are many times greater than I ever expected they would be when I enrolled. They seldom fall under \$100 a week. If your course cost four or five times more I would still consider it a good investment."

E. E. WINBORNE
1267 W. 48th St.,
Norfolk, Va.



Jumped from \$35 to \$100 a week

"Before I entered Radio I was making \$35 a week. Last week I earned \$110 servicing and selling Radios. I owe my success to N. R. I. You started me off on the right foot."

J. A. VAUGHN
Grand Radio & Appliance Co.,
3107 S. Grand Blvd.,
St. Louis, Mo.



\$500 extra in 6 months

"In looking over my records I find I made \$500 from January to May in my spare time. My best week brought me \$107. I have only one regret regarding your course—I should have taken it long ago."

HOYT MOORE
R. R. 3, Box 919,
Indianapolis, Ind.,

If you are earning a penny less than \$50 a week, send for my book of information on the opportunities in Radio. It is free. Clip the coupon NOW. Why be satisfied with \$25, \$30 or \$40 a week for longer than the short time it takes to get ready for Radio?

Radio's growth opening hundreds of \$50, \$75, \$100 a week jobs every year

In about ten years Radio has grown from a \$2,000,000 to a \$1,000,000,000 industry. Over 300,000 jobs have been created. Hundreds more are being opened every year by its continued growth. Many men and young men with the right training—the kind of training I give you—are stepping into Radio at two and three times their former salaries.

You may have many jobs to choose from

Broadcasting stations use engineers, operators, station managers and pay \$1,200 to \$5,000 a year. Manufacturers continually need testers, inspectors, foremen, engineers, service men, buyers, for jobs paying up to \$7,500 a year. Radio operators on ships enjoy life, see the world, with board and lodging free, and get good pay besides. Dealers and jobbers employ service men, salesmen, buyers, managers, and pay \$30 to \$100 a week. There are many other opportunities too. My book tells you about them.

So many opportunities many N. R. I. men make \$200 to \$1,000 in spare time while learning

The day you enroll with me I'll show you how to do 28 jobs, common in most every neighborhood, for spare time money. Throughout your course I send you information on servicing popular makes of sets; I give you the plans and ideas that are making \$200 to \$1,000 for hundreds of N. R. I. students in their spare time while studying. My course is famous as the course that pays for itself.

Talking Movies, Television, Aircraft Radio included

Special training in Talking Movies, Television and home Television experiments, Radio's use in Aviation, Servicing and Merchandising Sets, Broadcasting, Commercial and Ship Stations are included. I am so sure that I can train you satisfactorily that I will agree in writing to refund every penny of your tuition if you are not satisfied with my Lessons and Instruction Service upon completing.

64-page book of information FREE

Get your copy today. It tells you where Radio's good jobs are, what they pay, tells you about my course, what others who have taken it are doing and making. Find out what Radio offers you, without the slightest obligation. ACT NOW!

J. E. SMITH, President
National Radio Institute Dept., 2BX
Washington, D. C.

Our Own Home

Pioneer and World's Largest Home-Study Radio training organization devoted entirely to training men and young men for good jobs in the Radio industry. Our growth has paralleled Radio's growth. We occupy three hundred times as much floor space now as we did when organized in 1914.



Special Free Offer

"The Principles of Television"

For the first time this authoritative book on Television is made available to the general public. Until now only my students could have it. Act promptly, and I'll send you a copy FREE. In addition to my big free book "Rich Rewards in Radio." This book on Television gives you the fundamental facts about Television, its status, a comparison of sound and visual communication, and describes in detail the typical devices used in the six fundamental steps of Television. Get the facts about this coming field of great opportunity. Mail the coupon NOW.



ACT QUICKLY

I will give you my new 8 OUTFITS of RADIO PARTS for practical Home Experiments

You can build over 100 circuits with these outfits. You build and experiment with the circuits used in Crosley, Atwater - Kent, Eveready, Majestic, Zenith, and other popular sets. You learn how these sets work, why they work, how to make them work. This makes learning at home easy, fascinating, practical.

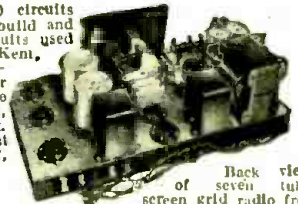

Back view of seven tube frequency receiver—only one of many circuits you can build with my outfits.

I am doubling and tripling the salaries of many in one year and less Find out about this quick way to

BIGGER PAY



FILL OUT AND MAIL THIS COUPON TODAY

J. E. SMITH, President
National Radio Institute, Dept. 2BX
Washington, D. C.

I want to take advantage of your Special Offer. Send me your two books, "The Principles of Television" and "Rich Rewards in Radio." I understand this does not obligate me and that no salesman will call.

Name.....
Address.....
City..... State.....

Lifetime Employment Service to all Graduates

NOW

On All Newsstands

25c The Copy

4-Color Cover
Over 100 Illustrations
96 Pages—9x12 in.



7-METER WAVE TRANSMITTER (MAGC)

MASTER CONTROL PANEL & AMPLIFIER

PHOTO CELLS

LENS

3 INCH MOTOR

60-HOLE SCANNING DISC

TO CURRENT SUPPLY

PHOTO CELLS

FOR SCANNING

SUBJECT BEING TELEVIEWED

"MIRIS" PICKS UP VOICE

COLUMBIA BROADCASTING STUDIO (TELEVISION)

BT 40

TELEPHONE CIRCUIT

15 MILES FROM NEW YORK

SHORT-WAVE (4902-METER) VOICE TRANSMITTER AT CROSS BAY, LONG ISLAND, N.Y.

VOICE AMPLIFIER

RECEIVING CIRCUIT (49 METERS)

1 STAGE R.F. DESIRABLE

2 STAGES TRANSFORMER COUPLED A.F.

DET.

VOICE RECEIVER (SHORT-WAVE REC)

3 RESISTANCE COUPLED STAGES

DEY. A.P. AMP. LIFIER

IMAGE RECEIVER (SHORT-WAVE REC)

"IMAGE" AND "VOICE"

NEON TUBE

VOICE

LENS 3" TO 10" DIA.

1200 R.P.M. SYNCHRONOUS MOTOR

TO MY RADIO FRIENDS WILL YOU BET 25c ON ME?

I want to ask you, as a special favor, to stop at your nearest newsstand and get an issue of **EVERYDAY SCIENCE AND MECHANICS** on the following unprecedented arrangement: Take the magazine home, look it over carefully and read those articles which are of interest to you. If, when you finish reading the magazine, you have found that you haven't had your money's worth, you may return the magazine to me and I will immediately refund your quarter, plus postage which you paid in returning the magazine.

I am making this unprecedented offer simply to get you acquainted with the magazine, and because I honestly believe that every issue of **EVERYDAY SCIENCE AND MECHANICS** will be worth many dollars to you with the important information you can't get elsewhere.

RADIO AND TELEVISION

I want you to look particularly at the new radio and television section containing a tremendous amount of information for radio experimenters, of the kind you cannot possibly get elsewhere.

This special offer to you is good during the month of November only. I hope you will do me the favor to take me up on this unprecedented proposition. Won't you please write and tell me how the book strikes you?

Cordially yours, **H. GERNSBACK.**

Diagram of a radio receiver circuit with various components labeled.

Diagram of a television receiver circuit.

Diagram of a vacuum tube circuit.

Diagram of a mechanical device.

EVERYDAY SCIENCE AND MECHANICS 100 Park Place, New York, N. Y.

RADIO DEALERS and SERVICEMEN

Here are two live items that wide-awake Dealers and Servicemen can cash in on.

THE RADIO DEALERS' ANTENAPLEX KIT

This RCA Antenaplex System, when properly installed, due to its superior design and complete shielding, transmits to the Outlet whatever the installed antenna receives. Interference that is not actually picked up at the antenna will be sealed out and not transmitted to the receivers. This system has been found very satisfactory to a great number of Dealers located in crowded and congested districts, where they have been bothered with a great deal of local interference. Many of you dealers who read this well know from sad experience what interference in radio reception will do when demonstrating good sets. It means many a sale lost through no fault of the set or your sales ability. Why not install one of these systems and decrease sales resistance?

The RCA Antenaplex Kit, Model RF-5000, consists of the following parts:

- 1—RCA Antensifier Box—Model RF-5001
- 1—RCA Antensifier—Model RF-5002
- 100 Feet—RCA Cabloy—Model RF-5050
- 100—RCA Cabloy Clamps—Model RF-5055
- 10—RCA Taplets—Model RF-5031
- 10—RCA Radio Outlet Flush Plates—Model RF-5634
- 1—RCA Terminet—Model RF-5091

Special Net Price to Dealers...\$100.00

An attractive proposition awaits Radio Service Organizations or Servicemen doing a fair volume of business who are equipped to handle the RCA Antenaplex System. If you have contacts with Electrical and Building Contractors or are in a position to closely contact apartment house owners, write us for further information.



One of the many uses of the Radio Pillow



The Radio Dealers' Antenaplex Kit

THE RADIO PILLOW

Feature these Radio Pillows to your trade. Every customer is a prospect. Independent Servicemen and Servicemen connected with Radio Dealers send for literature telling of the many uses and sales appeal of this product. It allows an individual to listen-in to their favorite program without disturbing others. Ideal for use in Guest Rooms, Nurseries, Hospitals, etc.

List Price\$6.95



Centralized Radio System

RCA Victor Co., Inc.

A Radio Corporation of America Subsidiary
Camden, New Jersey
"RADIO HEADQUARTERS"

Centralized Radio Section
RCA Victor Co., Inc.
Camden, N. J.

Please send me full details on

- The Radio Dealers' Antenaplex System
- The RCA Antenaplex System
- The Radio Pillow

Name.....

Address.....